



# ANHEUSER-BUSCH

Chesapeake Energy Arena - Oklahoma City

**messenger** **SPORTS**

NEW YORK | SEATTLE | SAN DIEGO



# RESTAURANT SIGN PLAN

## EXTERIOR SIGN SCHEDULE

- EX-01 - East Entrance Main Entrance ID
- EX-02 - East Entrance Dimensional Ribbons
- EX-03 - East Entrance Door Decal
- EX-04 - East Side Entrance Door ID
- EX-05 - East Side Wall Treatment
- EX-06 - Column Signs
- EX-07 - Elevator Wall Graphic

## INTERIOR SIGN SCHEDULE

- IN-01 - East Interior Wall Ribbon
- IN-02 - East Interior Wall Graphic & Message
- IN-03 - West Interior Wall Message
- IN-04 - Bar OKC Wall
- IN-05 - Bar Soffit
- IN-06 - Bar Column Wraps
- IN-07 - Hostess Wall Graphic

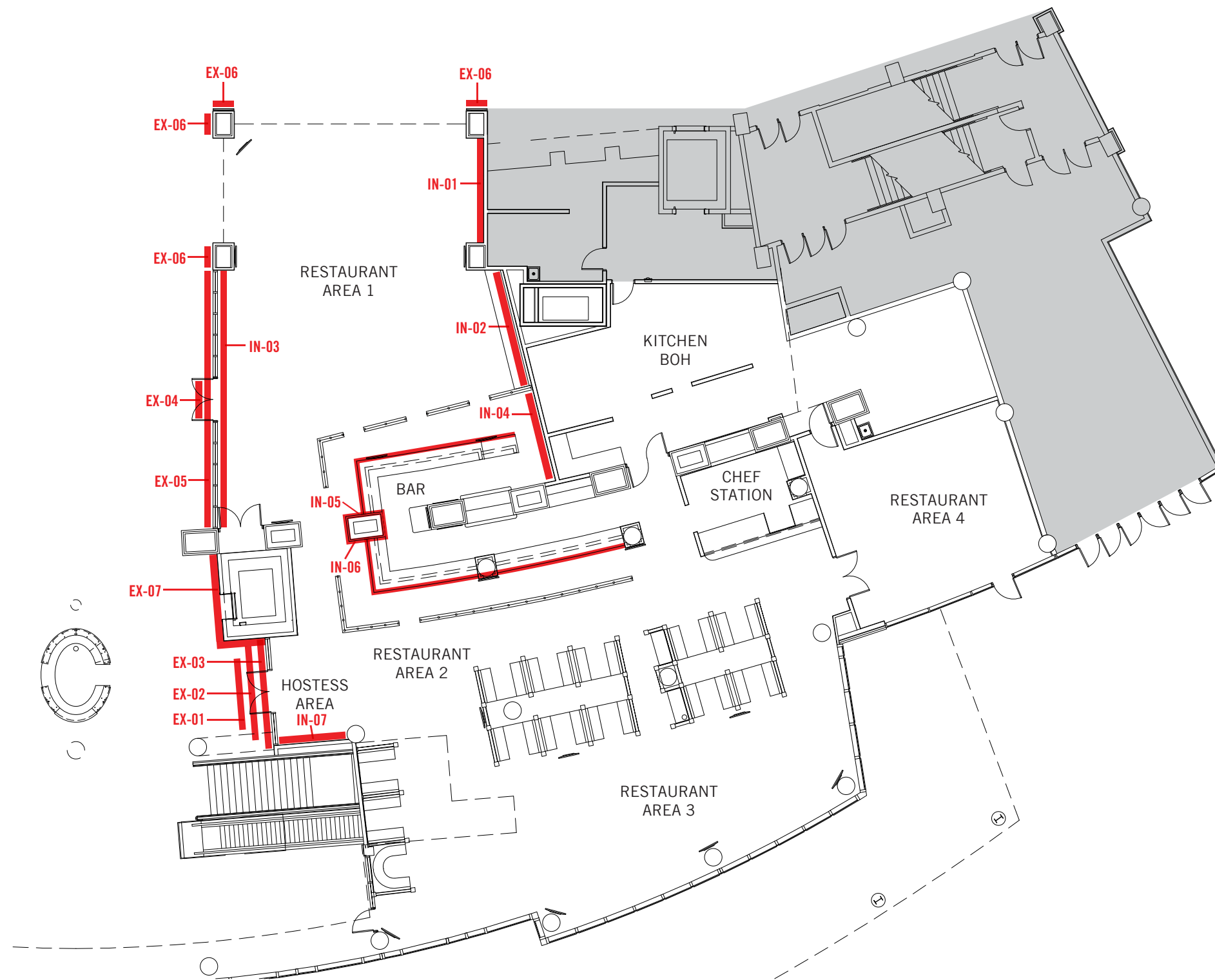



EXTERIOR CONCOURSE ELEVATIONS

SURVEY REQUIRED PRIOR TO  
PRODUCTION & INSTALL

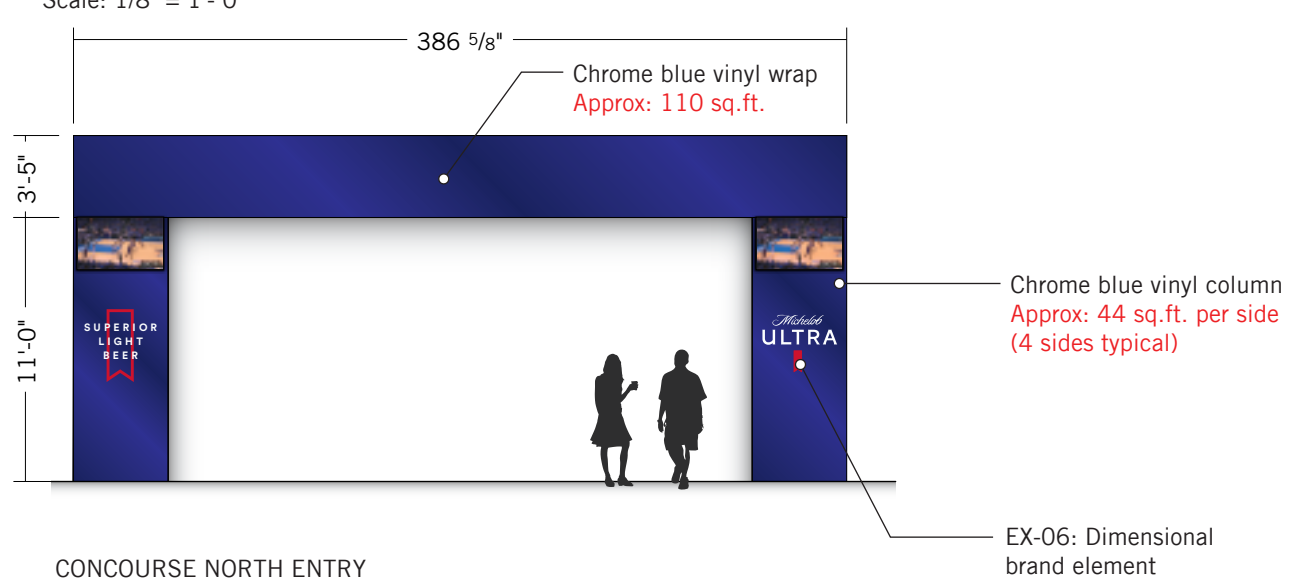
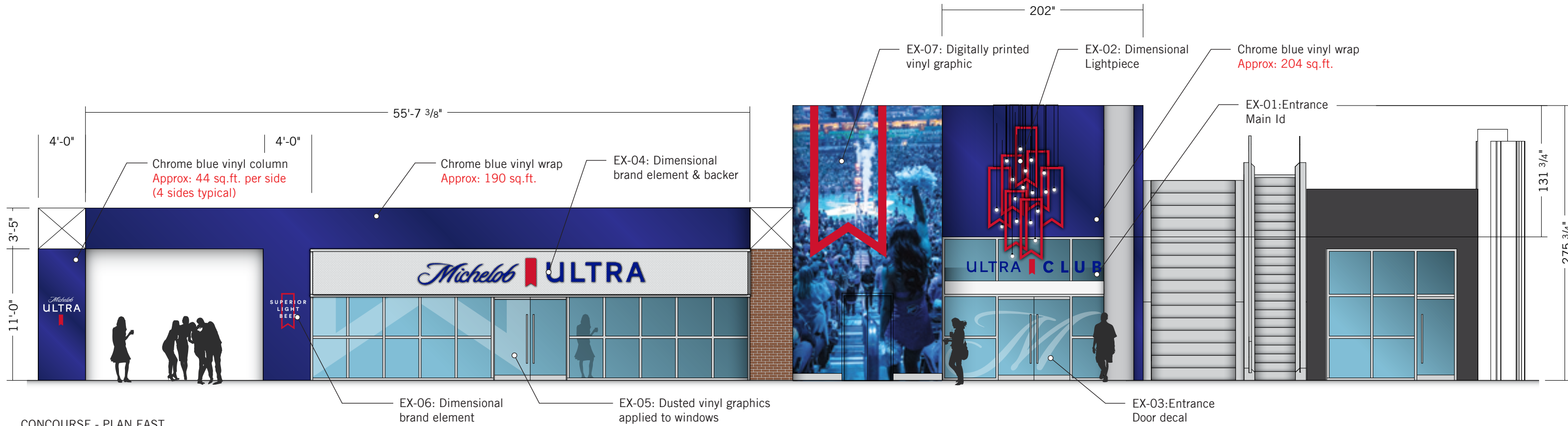

SURVEY REQUIRED PRIOR TO PRODUCTION & INSTALL

**EX 01 - East Entrance Main Entrance ID**  
ADHERED TO SOFFIT

Total Qty: 1

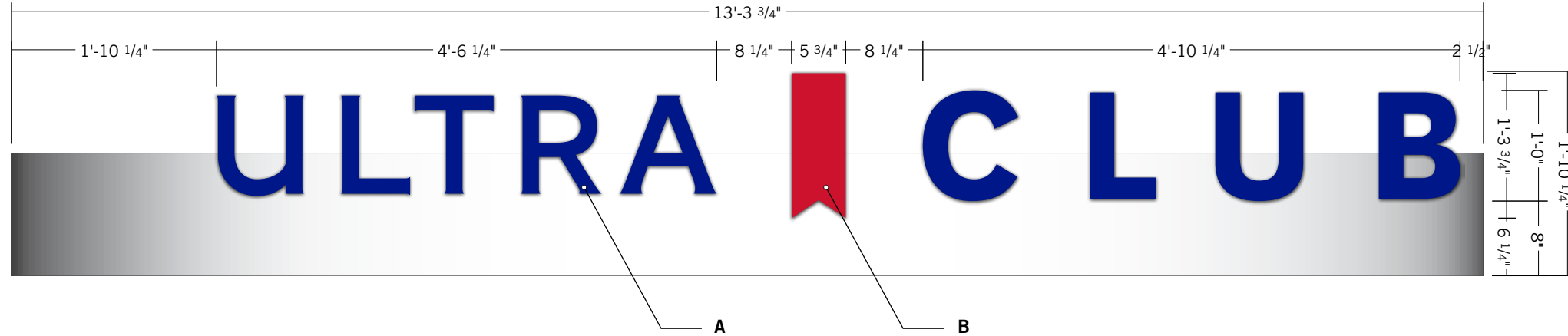

FRONT VIEW -EX-01

Scale: 3/4" = 1'- 0"

**A. ILLUMINATED MAIN ID**

1" deep face & edge lit acrylic with White LED illumination. Ribbon face & returns to have first surface applied translucent Blue vinyl. Logo backs to be aluminum painted Blue to match brand.

**B. RIBBON**

1" deep face & edge lit acrylic with White LED illumination. Ribbon face & returns to have first surface applied translucent red vinyl. Logo backs to be aluminum painted red to match brand.

**ELECTRICAL**

Remote power supply to be located above ceiling elements with service disconnect. **Final location TBD based on survey.**

Dedicated circuit with primary power to be located within 5'-0" of sign.

**C. MOUNTING FRAME**

Existing mounting frame to be painted white (survey required to determine optimal mounting).

**MOUNTING**

Letters & logo to be mounted to existing frame surface with fasteners as required. Additional aluminum angle support tabs will run behind letter and logo backs. Depending on facade finish the angle supports can match facade finish

JOB #  
**107034**

PROJECT NAME  
Anheuser Bush

LOCATION  
Chesapeake Energy Arena

CONTACT  
NA

PROJECT MANAGER  
NA

DESIGN  
NA

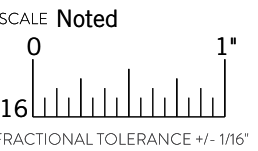

ORIGINAL DATE  
00.00.2020

REVISION DATES/NOTES  
00.00.2020

FILE LOCATION  
M:\

**SHOP DRAWING / SUBMITTAL REVIEW**

- APPROVED
- APPROVED WITH CHANGES NOTED
- REVISE / RESUBMIT

Submittal was reviewed for design conformity and general conformance to contract documents only. The contractor is responsible for tolerance, clearance, quantities, fabrication processes and techniques of construction, coordination of their work with other trades and full compliance with contract documents.

BY: \_\_\_\_\_

DATE: \_\_\_\_\_

© Messenger Corp 2020. All artwork contained herein is the copyrighted property of Messenger Corporation and may not be used or displayed in any medium without prior consent or paid compensation of \$5000 per proposal page or \$5000 per product containing unlawfully acquired Messenger Corporation artwork. Messenger Corporation will retain any and all usage rights to Logos, Designs, and Artwork. Usage rights (Limited or Complete) may be purchased from Messenger Corporation for an additional charge.

MESSENGER  
37 South Hudson Street  
Seattle, Washington 98134  
206.623.4525  
messengercorp.com

PAGE

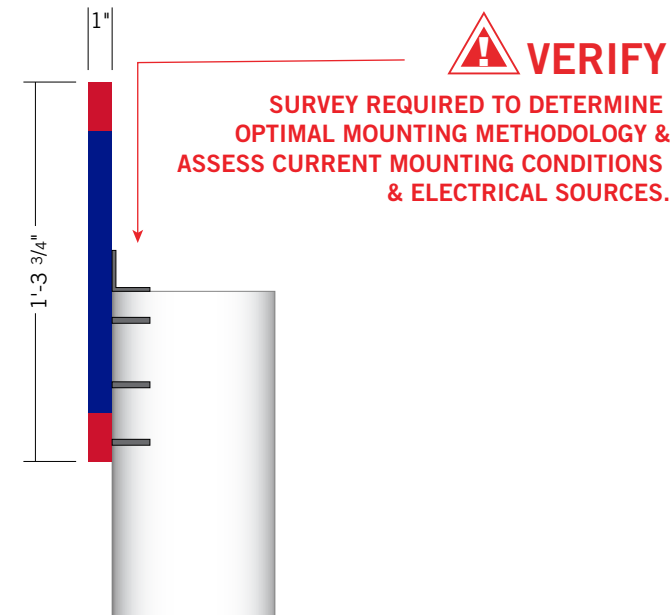

SIDEVIEW -EX-01

Scale: 1 1/2" = 1'- 0"

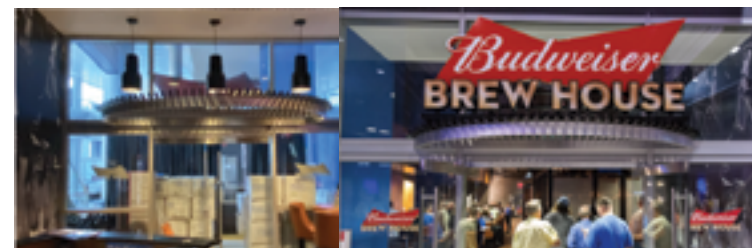

CURRENT CONDITIONS

Scale: NTS



EAST ENTRANCE ELEVATION MOCKUP

Scale: 3/8" = 1'- 0"

**PMS 186 C**  
Satin Finish

**PMS REFLEX BLUE C**  
Satin Finish

**MICHELOB ULTRA - EXTERIOR - CHESAPEAKE ENERGY ARENA**

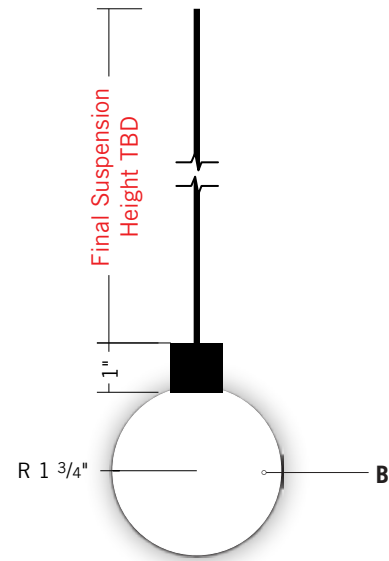

TYPICAL BULBS  
Scale: 3/16" = 1'- 0"

**VERIFY**  
SURVEY REQUIRED TO DETERMINE OPTIMAL MOUNTING HEIGHT & ASSESS CURRENT MOUNTING CONDITIONS & ELECTRICAL SOURCES.

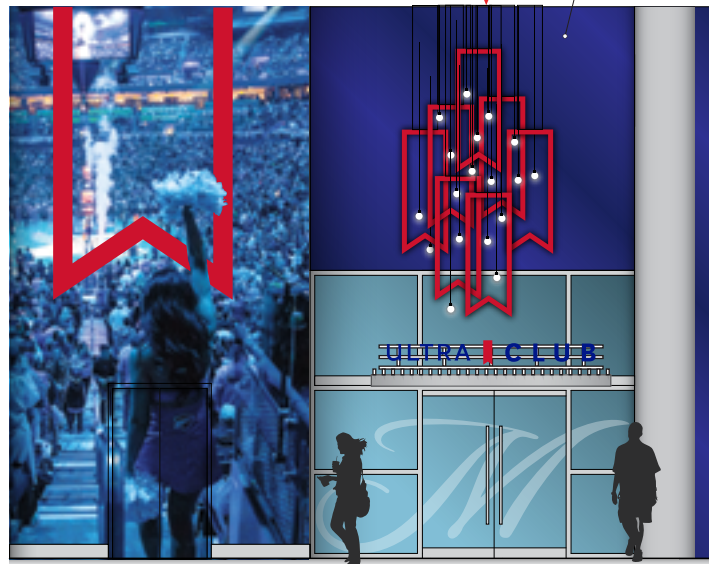

EAST ENTRANCE ELEVATION MOCKUP  
Scale: 1/8" = 1'- 0"

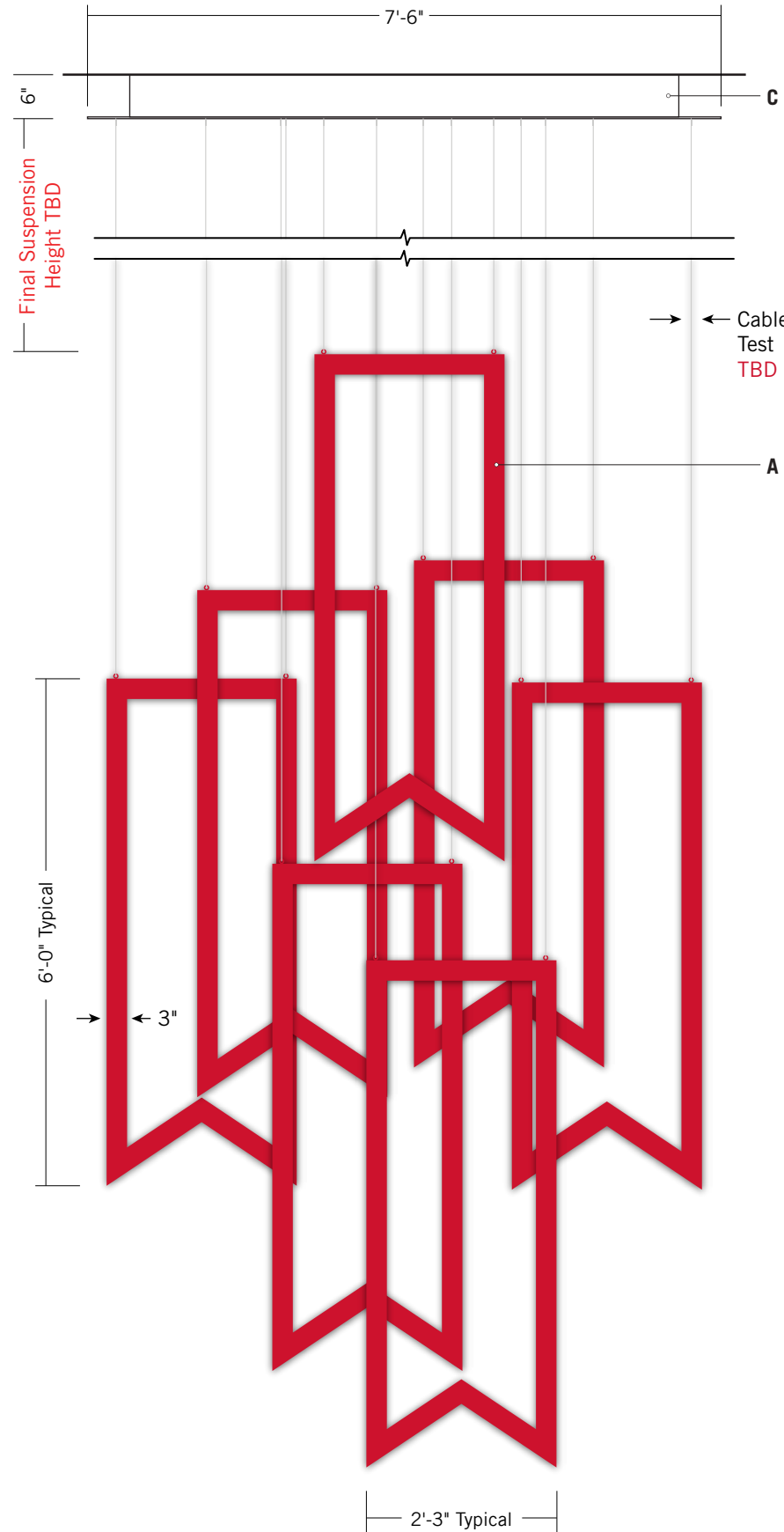

FRONT VIEW  
Scale: 1/2" = 1'- 0" QTY: 7

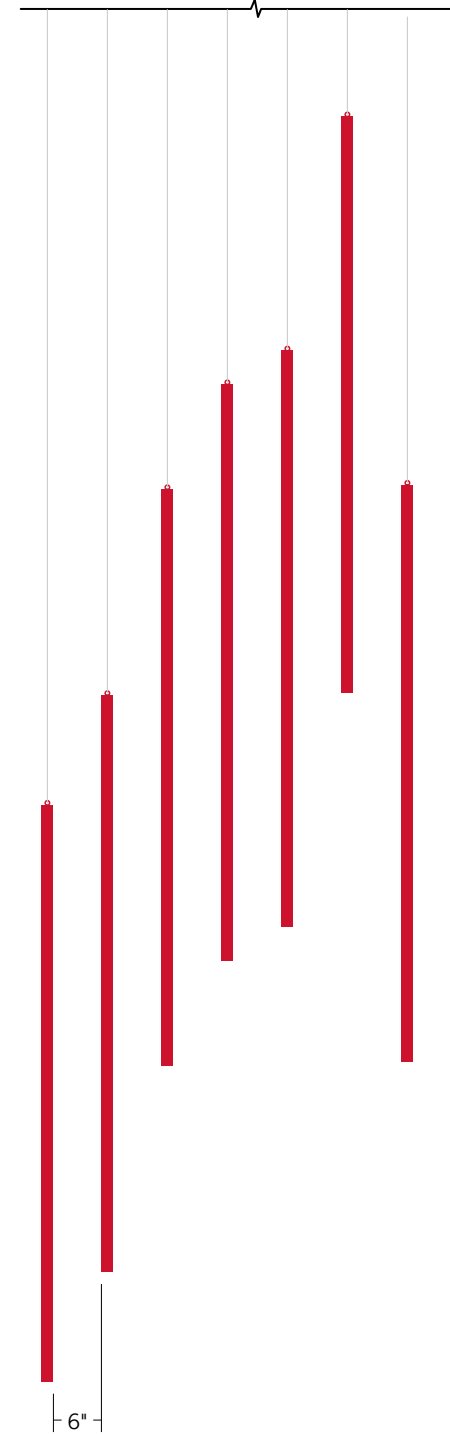

END VIEW  
Scale: 1/2" = 1'- 0"

SURVEY REQUIRED PRIOR TO PRODUCTION & INSTALL

**EX 02 - SUSPENDED MEDIUM DIMENSIONAL RIBBON**  
SUSPENDED FROM CEILING

Total Qty: 7

**A. ALUMINUM RIBBON**  
3 x 1-1/2 x 3/16 wall 6061-T6 Aluminum Rectangle Tube ribbon icon painted as indicated.

**RIBBON HANGERS**  
Steel Cable Connection points TBD  
All hardware painted to match supports.

**B. LIGHTING ELEMENTS**  
Final product TBD.

**C. OVERSIZED WIREWAY**  
Fabricated circular aluminum wireway with oversized face. Power supply will be housed within wireway. Painted to match ceiling TBD.

**MOUNTING**  
Aluminum supports to mount into ceiling with fasteners as required for surface (final mounting TBD).

**PMS 186 C**  
Satin Finish

**CHROME BLUE VINYL**  
OPT: 8518, 3M1080



JOB #  
**107034**

PROJECT NAME  
Anheuser Bush

LOCATION  
Chesapeake Energy Arena

CONTACT  
NA

PROJECT MANAGER  
NA

DESIGN  
NA

SCALE Noted  
0 1"  
16  
FRACTIONAL TOLERANCE +/- 1/16"

ORIGINAL DATE  
00.00.2020

REVISION DATES/NOTES  
00.00.2020

FILE LOCATION  
M:\

**SHOP DRAWING / SUBMITTAL REVIEW**

- APPROVED
- APPROVED WITH CHANGES NOTED
- REVISE / RESUBMIT

Submittal was reviewed for design conformity and general conformance to contract documents only. The contractor is responsible for tolerance, clearance, quantities, fabrication processes and techniques of construction, coordination of their work with other trades and full compliance with contract documents.

BY: \_\_\_\_\_

DATE: \_\_\_\_\_

© Messenger Corp 2020. All artwork contained herein is the copyrighted property of Messenger Corporation and may not be used or displayed in any medium without prior consent or paid compensation of \$5000 per proposal page or \$5000 per product containing unlawfully acquired Messenger Corporation artwork. Messenger Corporation will retain any and all usage rights to Logos, Designs, and Artwork. Usage rights (Limited or Complete) may be purchased from Messenger Corporation for an additional charge.

MESSENGER  
37 South Hudson Street  
Seattle, Washington 98134  
206.623.4525  
messengercorp.com

PAGE

**MICHELOB ULTRA - EXTERIOR - CHESAPEAKE ENERGY ARENA**

SURVEY REQUIRED PRIOR TO PRODUCTION & INSTALL

**EX 03 - EAST ENTRY  
M DOOR GRAPHIC  
ADHERED TO GLASS**

Total Qty: 1



**A. VINYL BACKGROUND**  
Michelob Script "M" script to be a first surface applied vinyl graphic.



**VERIFY**   
**SURVEY REQUIRED TO VERIFY:**  
**EXISTING WINDOW DIMENSIONS**  
**DETERMINE CONDITION OF EXISTING SIGN FOR APPLICATION OF NEW GRAPHICS.**

EAST ENTRY DOOR DECAL

Scale: 1/4" = 1'- 0"



EAST ENTRANCE ELEVATION MOCKUP

Scale: 1/4" = 1'- 0"

JOB #  
**107034**

PROJECT NAME  
Anheuser Bush

LOCATION  
Chesapeake Energy Arena

CONTACT  
NA

PROJECT MANAGER  
NA

DESIGN  
NA



ORIGINAL DATE  
00.00.2020

REVISION DATES/NOTES  
00.00.2020

FILE LOCATION  
M:\

**SHOP DRAWING / SUBMITTAL REVIEW**

- APPROVED
- APPROVED WITH CHANGES NOTED
- REVISE / RESUBMIT

Submittal was reviewed for design conformity and general conformance to contract documents only. The contractor is responsible for tolerance, clearance, quantities, fabrication processes and techniques of construction, coordination of their work with other trades and full compliance with contract documents.

BY: \_\_\_\_\_

DATE: \_\_\_\_\_

© Messenger Corp 2020. All artwork contained herein is the copyrighted property of Messenger Corporation and may not be used or displayed in any medium without prior consent or paid compensation of \$5000 per proposal page or \$5000 per product containing unlawfully acquired Messenger Corporation artwork. Messenger Corporation will retain any and all usage rights to Logos, Designs, and Artwork. Usage rights (Limited or Complete) may be purchased from Messenger Corporation for an additional charge.

MESSINGER  
37 South Hudson Street  
Seattle, Washington 98134  
206.623.4525  
messengercorp.com

**Dusted Vinyl**

PAGE

**MICHELOB ULTRA - EXTERIOR - CHESAPEAKE ENERGY ARENA**

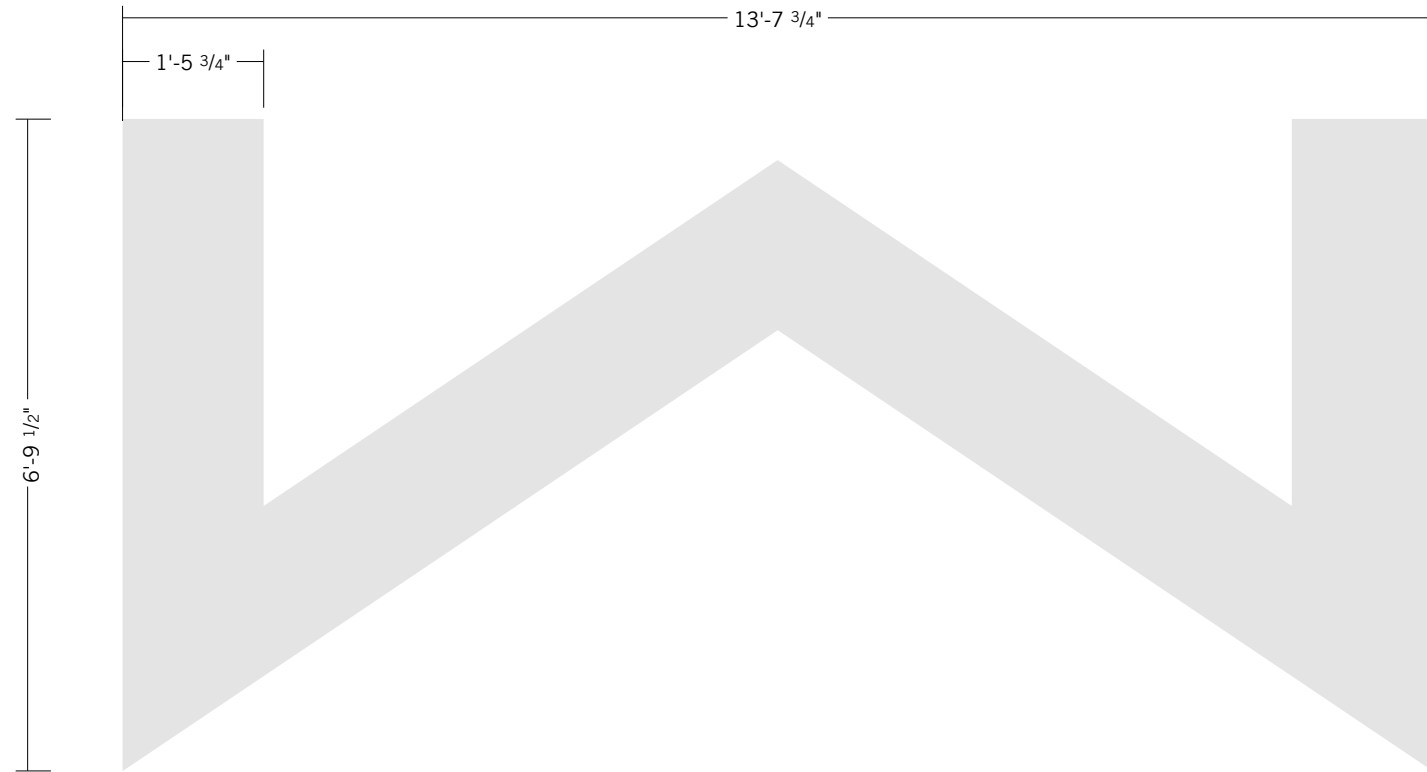

ELEVATION MOCKUP

Scale: 1/2" = 1'- 0"

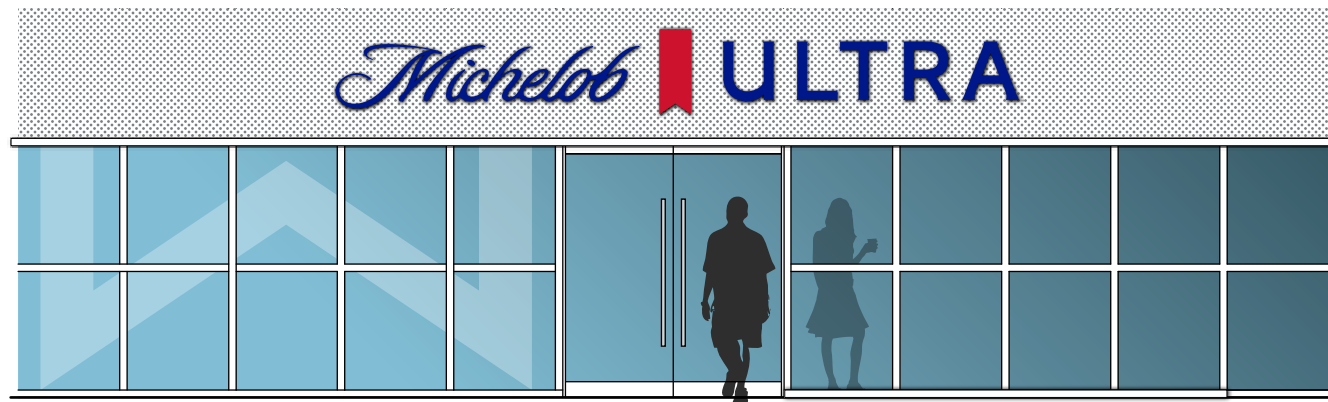

ELEVATION MOCKUP

Scale: 3/16" = 1'- 0"

SURVEY REQUIRED PRIOR TO PRODUCTION & INSTALL

**EX 05 - EAST ENTRANCE  
MICHELOB RIBBON  
ADHERED TO GLASS**

Total Qty: 1

**A. VINYL BACKGROUND**

Background vinyl graphic to be direct printed.

**MOUNTING**

Applied directly to Window surface as indicated



**messenger**

JOB #  
**107034**

PROJECT NAME  
**Anheuser Bush - MICHELOB**

LOCATION  
**Chesapeake Energy Arena**

CONTACT  
**NA**

PROJECT MANAGER  
**NA**

DESIGN  
**NA**

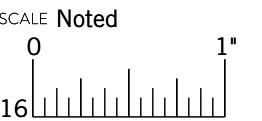

FRACTIONAL TOLERANCE +/- 1/16"

ORIGINAL DATE  
**00.00.2020**

REVISION DATES/NOTES  
**00.00.2020**

FILE LOCATION  
**M:\**

**SHOP DRAWING / SUBMITTAL REVIEW**

- APPROVED
- APPROVED WITH CHANGES NOTED
- REVISE / RESUBMIT

Submittal was reviewed for design conformity and general conformance to contract documents only. The contractor is responsible for tolerance, clearance, quantities, fabrication processes and techniques of construction, coordination of their work with other trades and full compliance with contract documents.

BY: \_\_\_\_\_

DATE: \_\_\_\_\_

© Messenger Corp 2020. All artwork contained herein is the copyrighted property of Messenger Corporation and may not be used or displayed in any medium without prior consent or paid compensation of \$5000 per proposal page or \$5000 per product containing unlawfully acquired Messenger Corporation artwork. Messenger Corporation will retain any and all usage rights to Logos, Designs, and Artwork. Usage rights (Limited or Complete) may be purchased from Messenger Corporation for an additional charge.

MESSENGER  
37 South Hudson Street  
Seattle, Washington 98134  
206.623.4525  
messengercorp.com

**Dusted Vinyl**

PAGE

**MICHELOB ULTRA - EXTERIOR - CHESAPEAKE ENERGY ARENA**

SURVEY REQUIRED PRIOR TO PRODUCTION & INSTALL

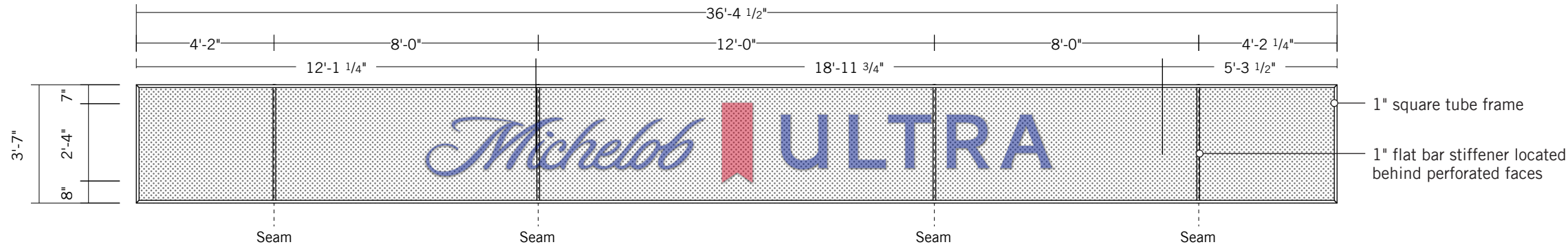

FRAME VIEW

Scale: 3/16" = 1'- 0"

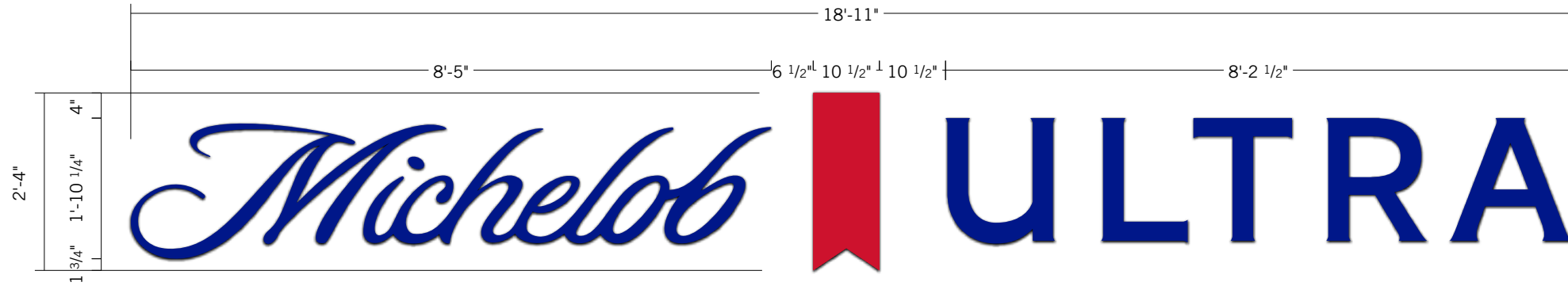

ELEVATION MOCKUP - PANELING AND FRAME VIEW

Scale: 1/2" = 1'- 0"

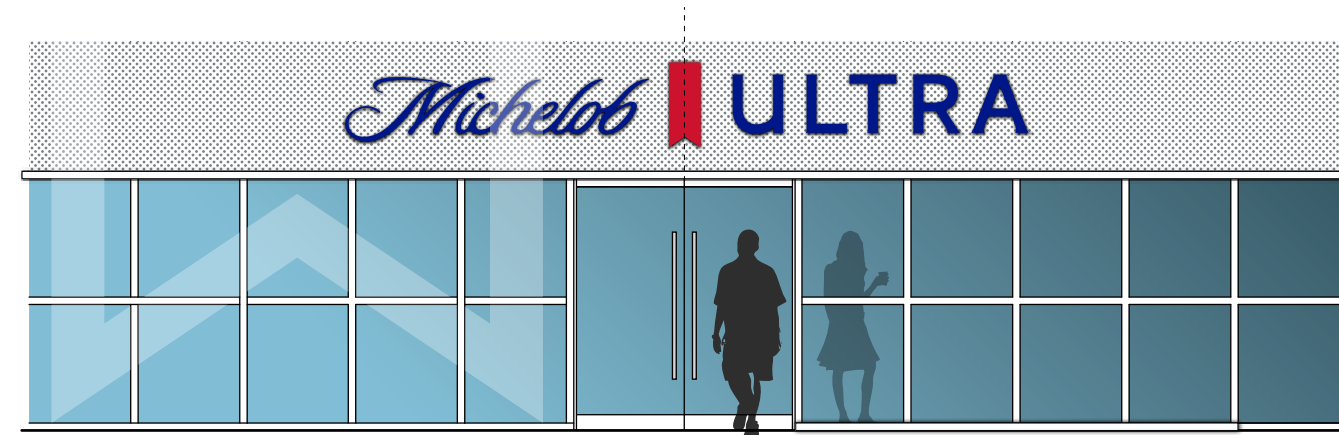

ELEVATION MOCKUP - NORTHEAST ENTRY

Scale: 3/16" = 1'- 0"

**EX 04.01 - EAST ENTRANCE PERFERATED STEEL MOUNTED TO STOREFRONT**

Total Qty: 1

**A. NON-ILLUMINATED MAIN ID LETTERING**

1" deep face & edge Painted Michelob Reflex Blue.

1" deep face & edge Painted Michelob Red.

**MOUNTING**

Letters & logo to be mounted to EX 04.B surface with fasteners as required.

**B. PERFORATED ALUMINUM PANELING**

1/8" perforated faces aluminum faces. Perforated paneling to be attached to a 1"x1" square tube framing system with faces and frame painted white.

**MOUNTING**

Assembled frame will be mounted to facade with aluminum angle mounting tabs (located at top & bottom) Flat bar stiffeners behind the seams to prevent bowing.

<https://www.mcnichols.com/>



JOB #  
**107034**

PROJECT NAME  
Anheuser Bush - MICHELOB

LOCATION  
Chesapeake Energy Arena

CONTACT  
NA

PROJECT MANAGER  
NA

DESIGN  
NA

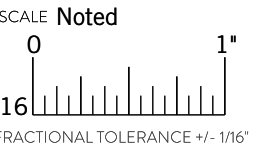

ORIGINAL DATE  
00.00.2020

REVISION DATES/NOTES  
00.00.2020

FILE LOCATION  
M:\

**SHOP DRAWING / SUBMITTAL REVIEW**

- APPROVED
- APPROVED WITH CHANGES NOTED
- REVISE / RESUBMIT

Submittal was reviewed for design conformity and general conformance to contract documents only. The contractor is responsible for tolerance, clearance, quantities, fabrication processes and techniques of construction, coordination of their work with other trades and full compliance with contract documents.

BY: \_\_\_\_\_

DATE: \_\_\_\_\_

© Messenger Corp 2020. All artwork contained herein is the copyrighted property of Messenger Corporation and may not be used or displayed in any medium without prior consent or paid compensation of \$5000 per proposal page or \$5000 per product containing unlawfully acquired Messenger Corporation artwork. Messenger Corporation will retain any and all usage rights to Logos, Designs, and Artwork. Usage rights (Limited or Complete) may be purchased from Messenger Corporation for an additional charge.

	<b>White</b> Matte Finish
--	------------------------------

	<b>PMS 186 C</b> Satin Finish
--	----------------------------------

	<b>PMS REFLEX BLUE C</b> Satin Finish
--	--

MESSENGER  
37 South Hudson Street  
Seattle, Washington 98134  
206.623.4525  
messengercorp.com

PAGE



**MICHELOB ULTRA - EXTERIOR - CHESAPEAKE ENERGY ARENA**

SURVEY REQUIRED PRIOR TO PRODUCTION & INSTALL

**EX 06 - ENTRY COLUMN SIGNS**

**ON INTERIOR COLUMN**

Total Qty: 4 (2 OF EACH)



JOB #  
**107034**

PROJECT NAME  
**Anheuser Bush - MICHELOB**

LOCATION  
**Chesapeake Energy Arena**

CONTACT  
**NA**

PROJECT MANAGER  
**NA**

DESIGN  
**NA**

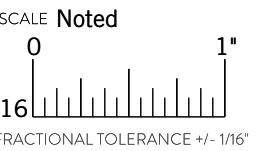

ORIGINAL DATE  
**00.00.2020**

REVISION DATES/NOTES  
**00.00.2020**

FILE LOCATION  
**M:\**

**SHOP DRAWING / SUBMITTAL REVIEW**

- APPROVED
- APPROVED WITH CHANGES NOTED
- REVISE / RESUBMIT

Submittal was reviewed for design conformity and general conformance to contract documents only. The contractor is responsible for tolerance, clearance, quantities, fabrication processes and techniques of construction, coordination of their work with other trades and full compliance with contract documents.

BY: \_\_\_\_\_

DATE: \_\_\_\_\_

© Messenger Corp 2020. All artwork contained herein is the copyrighted property of Messenger Corporation and may not be used or displayed in any medium without prior consent or paid compensation of \$5000 per proposal page or \$5000 per product containing unlawfully acquired Messenger Corporation artwork. Messenger Corporation will retain any and all usage rights to Logos, Designs, and Artwork. Usage rights (Limited or Complete) may be purchased from Messenger Corporation for an additional charge.

MESSENGER  
37 South Hudson Street  
Seattle, Washington 98134  
206.623.4525  
messengercorp.com

PAGE

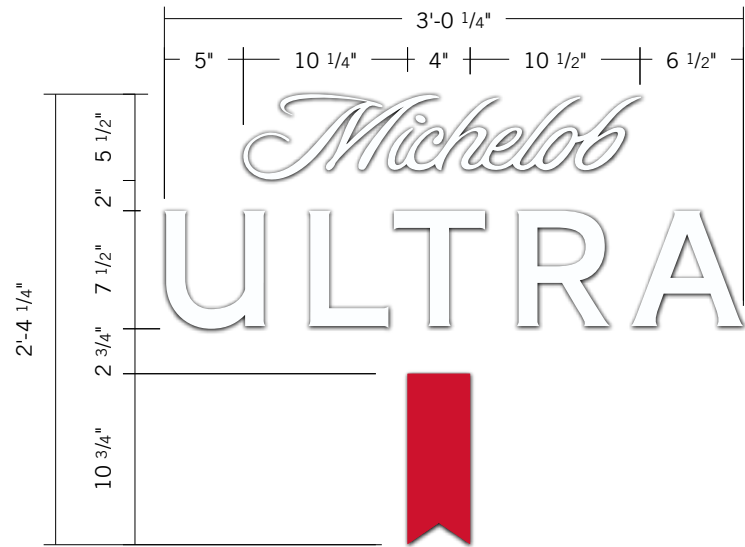

DIMENSIONAL WALL GRAPHIC MICHELOB - EX 06.A

Scale: 1" = 1'- 0"

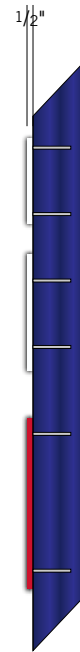

SIDE VIEW MICHELOB - EX 06.A

Scale: 1" = 1'- 0"

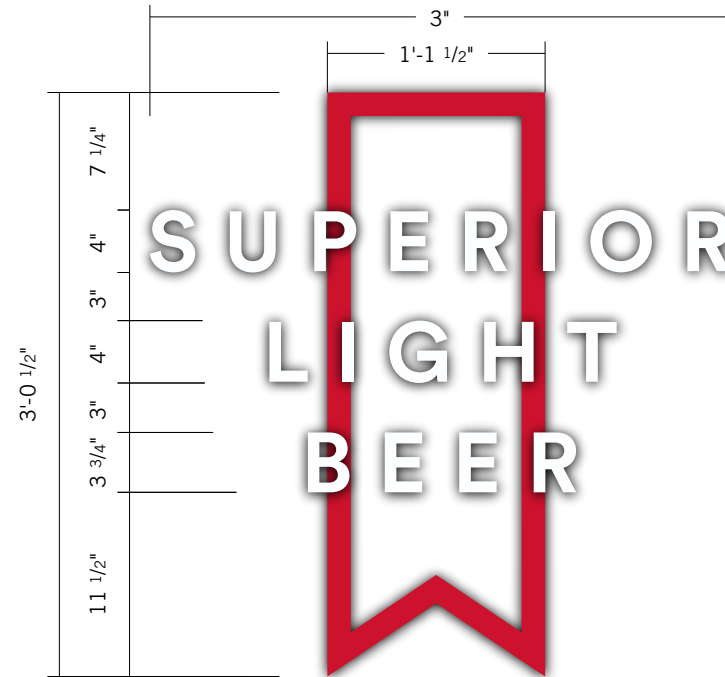

DIMENSIONAL WALL GRAPHIC RIBBON - EX 06.B

Scale: 1" = 1'- 0"

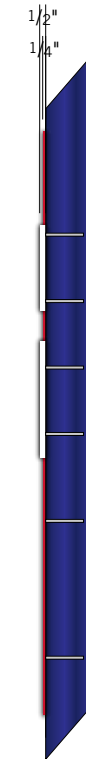

SIDE VIEW RIBBON - EX 06.B

Scale: 1" = 1'- 0"

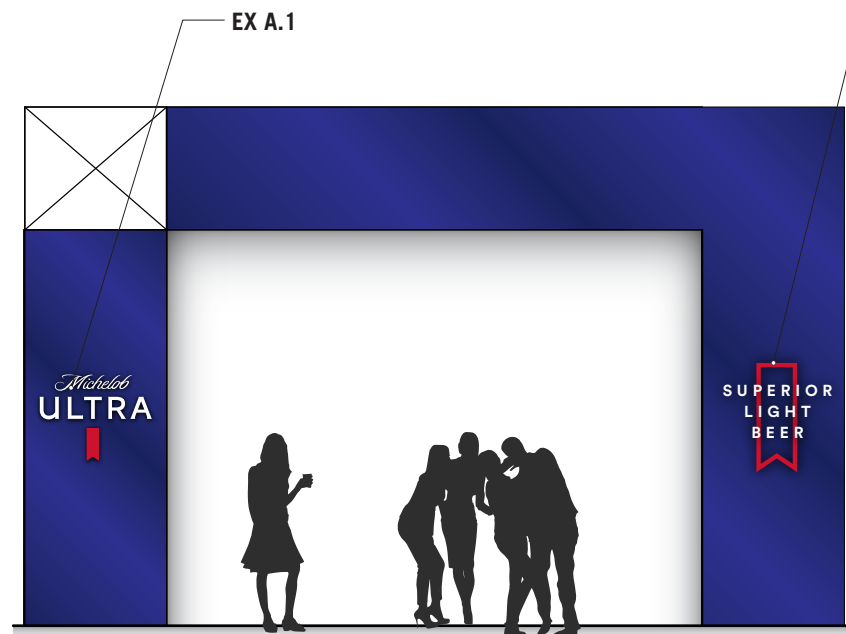

PLAN NORTHEAST ENTRY AREA

Scale: 3/16" = 1'- 0"

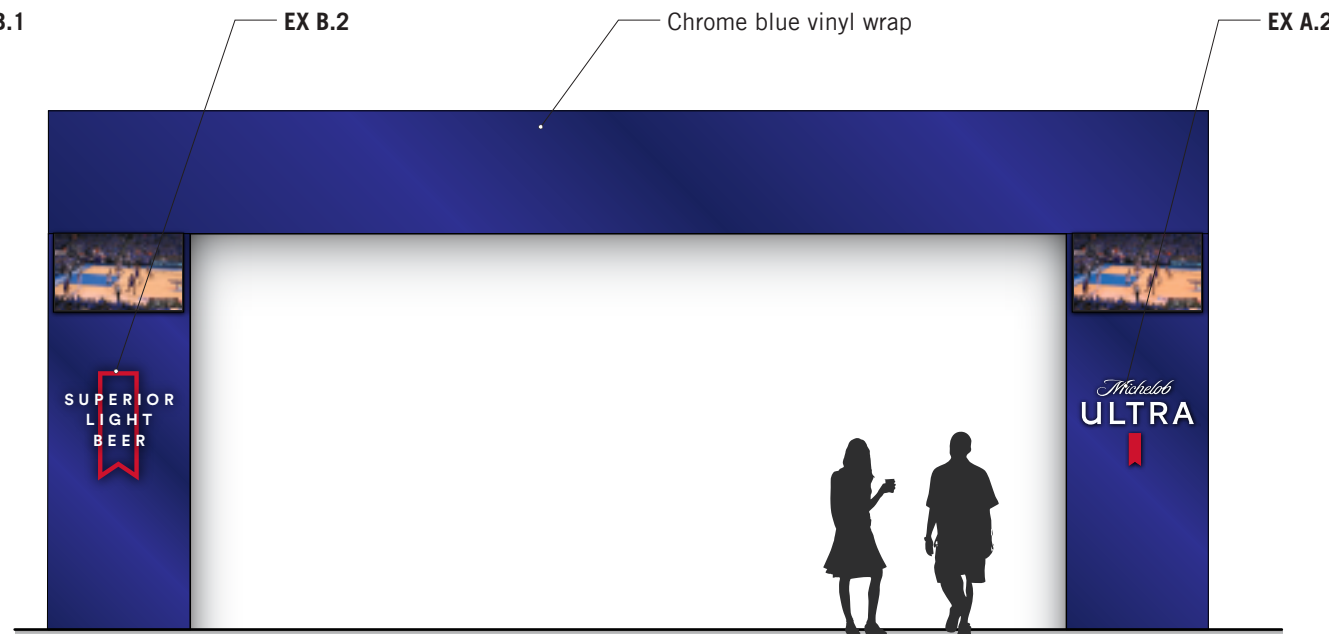

CONCOURSE NORTH ENTRY

Scale: 3/16" = 1'- 0"

	White Matte Finish
	PMS 186 C Satin Finish
	3M 1080 Blue Chrome Vinyl

**MICHELOB ULTRA - EXTERIOR - CHESAPEAKE ENERGY ARENA**

SURVEY REQUIRED PRIOR TO PRODUCTION & INSTALL

**EX 07 - ELEVATOR WALL GRAPHIC Option 2**  
**ADHERED TO GLASS PANELING**

Total Qty: 1



JOB #  
**107034**

PROJECT NAME  
 Anheuser Bush

LOCATION  
 Chesapeake Energy Arena

CONTACT  
 NA

PROJECT MANAGER  
 NA

DESIGN  
 NA

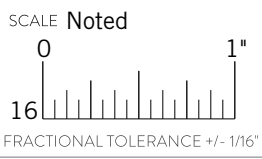

ORIGINAL DATE  
 00.00.2020

REVISION DATES/NOTES  
 00.00.2020

FILE LOCATION  
 M:\

**SHOP DRAWING / SUBMITTAL REVIEW**

- APPROVED
- APPROVED WITH CHANGES NOTED
- REVISE / RESUBMIT

Submittal was reviewed for design conformity and general conformance to contract documents only. The contractor is responsible for tolerance, clearance, quantities, fabrication processes and techniques of construction, coordination of their work with other trades and full compliance with contract documents.

BY: \_\_\_\_\_

DATE: \_\_\_\_\_

© Messenger Corp 2020. All artwork contained herein is the copyrighted property of Messenger Corporation and may not be used or displayed in any medium without prior consent or paid compensation of \$5000 per proposal page or \$5000 per product containing unlawfully acquired Messenger Corporation artwork. Messenger Corporation will retain any and all usage rights to Logos, Designs, and Artwork. Usage rights (Limited or Complete) may be purchased from Messenger Corporation for an additional charge.

MESSENGER  
 37 South Hudson Street  
 Seattle, Washington 98134  
 206.623.4525  
 messengercorp.com

PAGE

CORNER  
 4' 3/4"      5'-11"

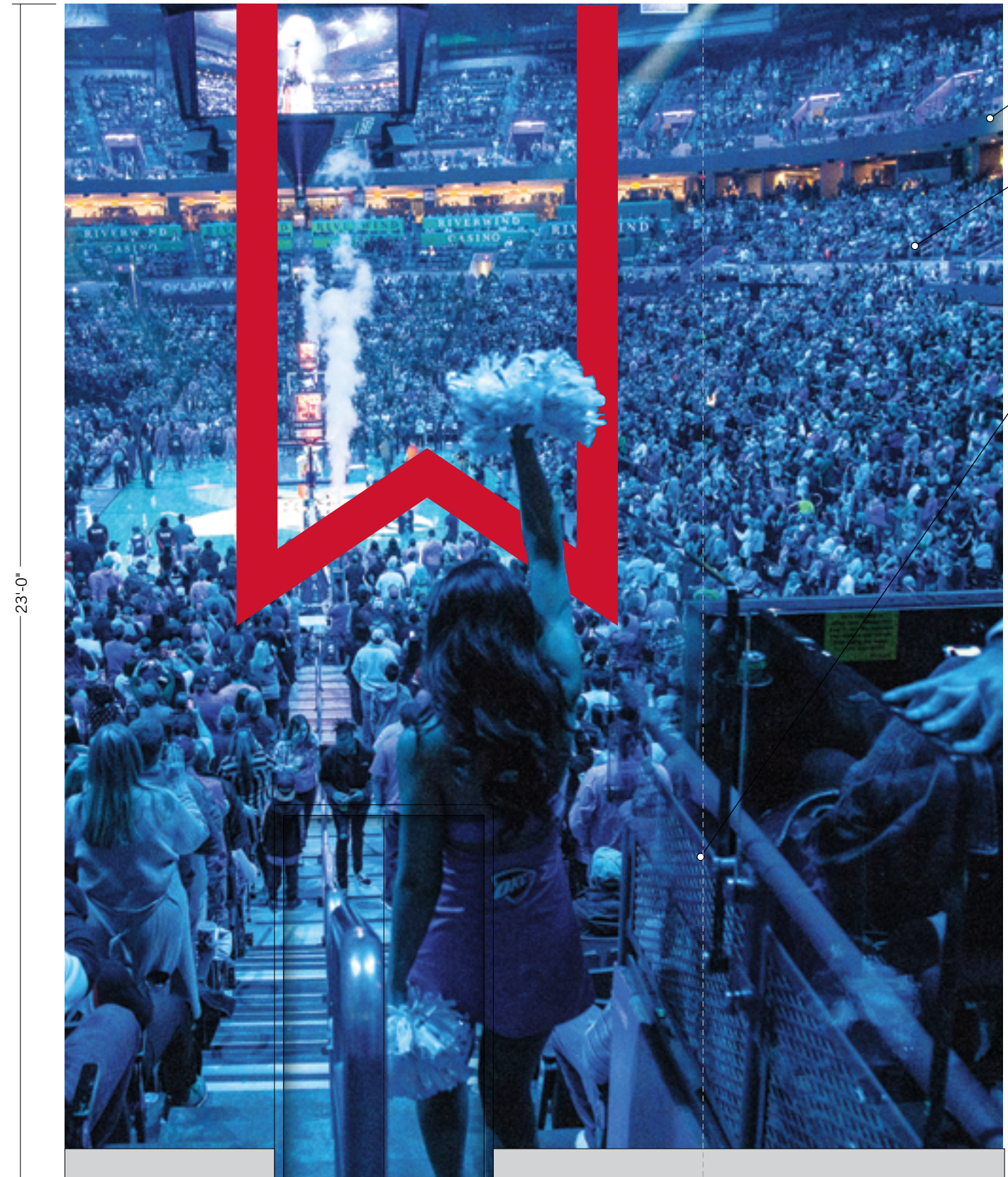

Option 2

**NOTE:** Potential team imagery assets to be provided

**VERIFY**

**SURVEY REQUIRED TO VERIFY:**

**EXISTING WALL DIMENSIONS**

**DETERMINE CONDITION OF EXISTING SIGN FOR APPLICATION OF NEW GRAPHICS.**

EAST ENTRANCE ELEVATOR GRAPHIC

Scale: 1/4" = 1'- 0"



INTERIOR CONCOURSE ELEVATIONS

SURVEY REQUIRED PRIOR TO PRODUCTION & INSTALL

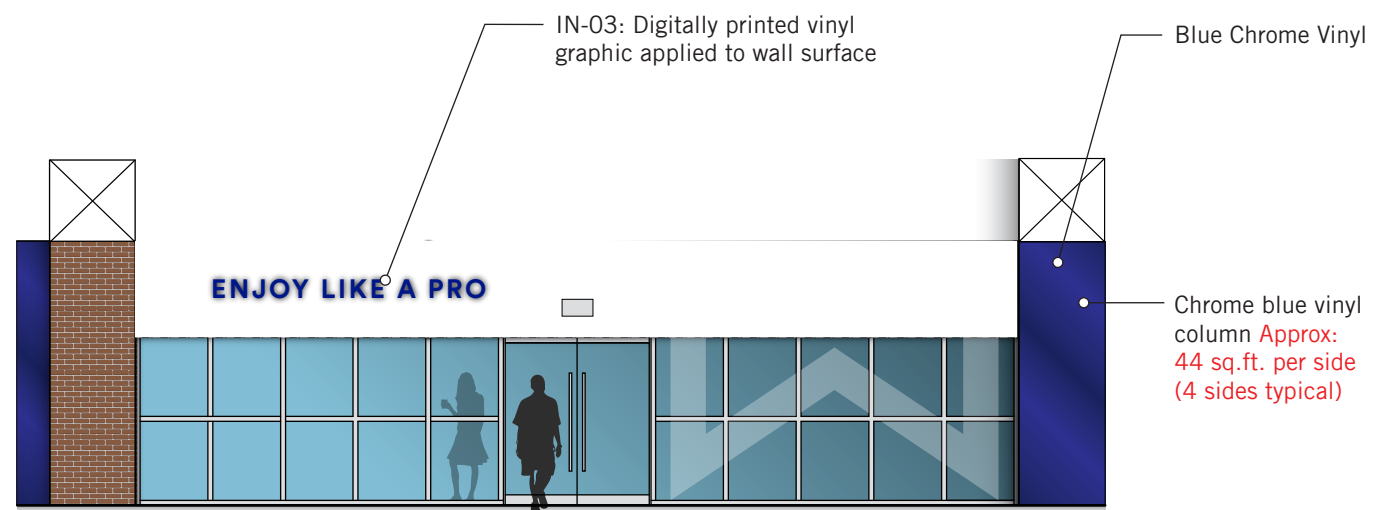

CONCOURSE - PLAN NORTHEAST ENTRY AREA

Scale: 1/8" = 1'- 0"



EAST WALL - DINING & BAR

Scale: 1/8" = 1'- 0"

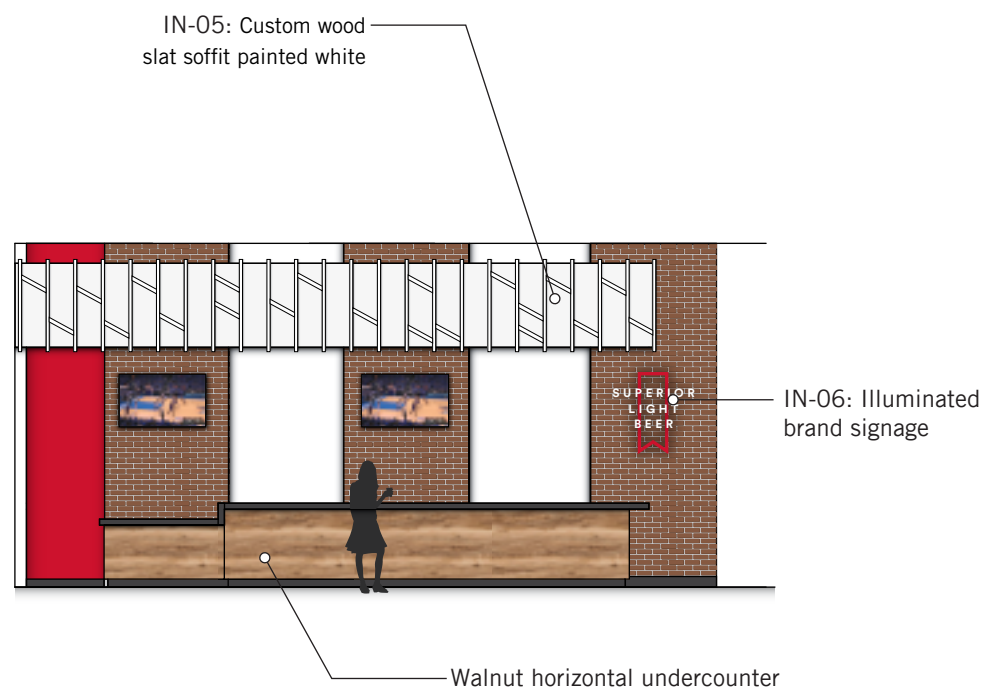

NORTH BAR WALL

Scale: 1/8" = 1'- 0"

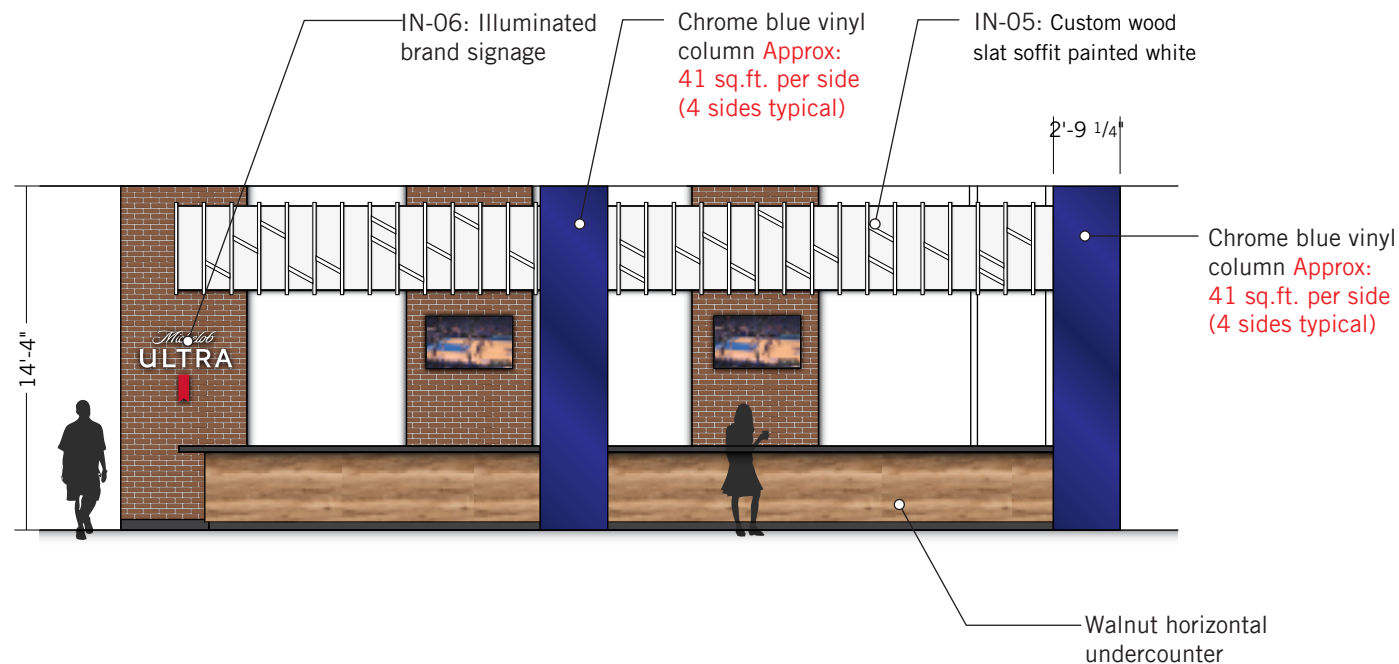

SOUTH BAR WALL

Scale: 1/8" = 1'- 0"

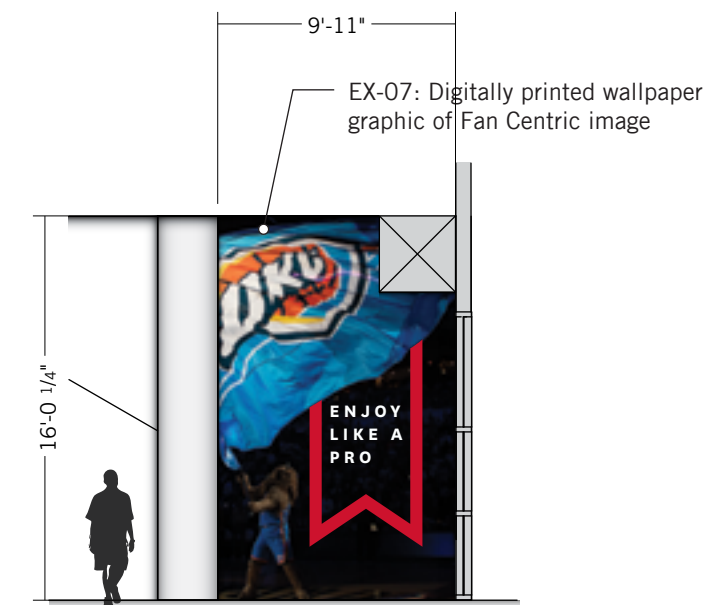

HOSTESS WALL

Scale: 1/8" = 1'- 0"

SURVEY REQUIRED PRIOR TO PRODUCTION & INSTALL

**IN 01 - SUSPENDED MEDIUM DIMENSIONAL RIBBON**  
**SUSPENDED FROM CEILING**

Total Qty: 1

**A. ALUMINUM RIBBON**

4 x 2 x 1/4" wall 6063-T52 Aluminum Rectangle Tube ribbon icon painted as indicated.

**B. RIBBON SUPPORTS**

1" x 1" x 1/4" aluminum round tube supports and to be welded to 1/4" aluminum mounting plate(s). 3'-10" x 6" x 1/4" mounting plate(s) mounted at ceiling and top of ribbon painted white with a matte finish. All hardware painted to match supports.

**MOUNTING**

Aluminum supports to mount into ceiling with fasteners as required for surface (final mounting TBD).



JOB #  
**10734**

PROJECT NAME  
Anheuser Bush

LOCATION  
Chesapeake Energy Arena

CONTACT  
NA

PROJECT MANAGER  
NA

DESIGN  
NA

SCALE **Noted**  
  
 FRACTIONAL TOLERANCE +/- 1/16"

ORIGINAL DATE  
00.00.2020

REVISION DATES/NOTES  
00.00.2020

FILE LOCATION  
M:\

**SHOP DRAWING / SUBMITTAL REVIEW**

- APPROVED
- APPROVED WITH CHANGES NOTED
- REVISE / RESUBMIT

Submittal was reviewed for design conformity and general conformance to contract documents only. The contractor is responsible for tolerance, clearance, quantities, fabrication processes and techniques of construction, coordination of their work with other trades and full compliance with contract documents.

BY: \_\_\_\_\_

DATE: \_\_\_\_\_

© Messenger Corp 2020. All artwork contained herein is the copyrighted property of Messenger Corporation and may not be used or displayed in any medium without prior consent or paid compensation of \$5000 per proposal page or \$5000 per product containing unlawfully acquired Messenger Corporation artwork. Messenger Corporation will retain any and all usage rights to Logos, Designs, and Artwork. Usage rights (Limited or Complete) may be purchased from Messenger Corporation for an additional charge.

MESSENGER  
37 South Hudson Street  
Seattle, Washington 98134  
206.623.4525  
messengercorp.com

PAGE

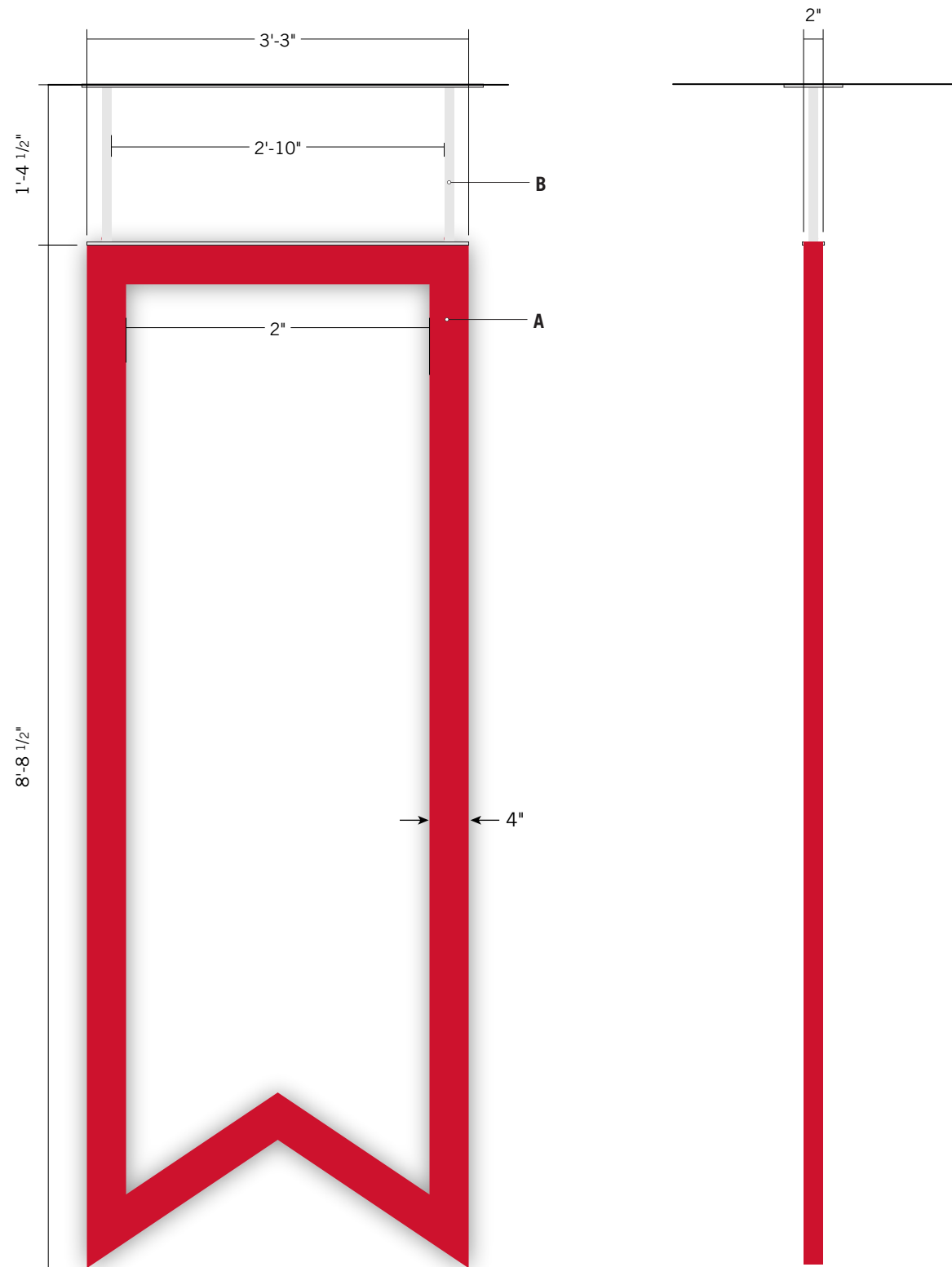

FRONT VIEW - IN.01

Scale: 3/4" = 1'- 0"

END VIEW - IN.01

Scale: 3/4" = 1'- 0"

**VERIFY**   
 SURVEY REQUIRED TO VERIFY:  
 MOUNTING FORMAT AND SUSPENSION  
 HEIGHT COMPARED TO DRAWINGS.

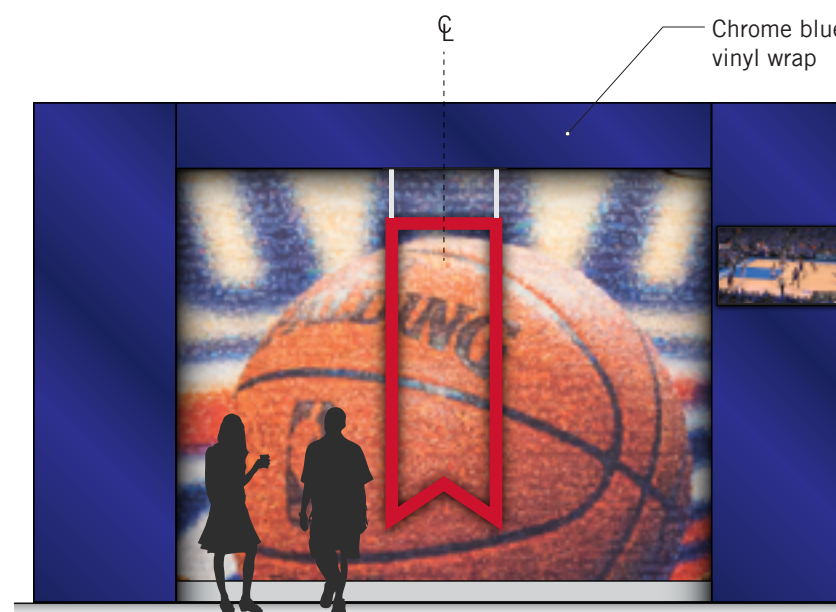

ELEVATION MOCKUP

Scale: 3/16" = 1'- 0"

	White Matte Finish
	PMS 186 C Satin Finish
	3M 1080 Blue Chrome Vinyl

SURVEY REQUIRED PRIOR TO PRODUCTION & INSTALL

**IN 02 - EAST INTERIOR WALL GRAPHIC & MESSAGE APPLIED TO WALL**



Total Qty: 1

**A. BRAND STATEMENT DIMENSIONAL TYPE**  
1" Acrylic cut type. Pin mounted flush to wall

**B. WALL GRAPHICS**  
Digital printed graphic onto wallpaper material with a satin finish.

**MOUNTING**  
Graphic Pattern applied directly to wall

JOB #  
**10734**

PROJECT NAME  
Anheuser Bush

LOCATION  
Chesapeake Energy Arena

CONTACT  
NA

PROJECT MANAGER  
NA

DESIGN  
NA



ORIGINAL DATE  
00.00.2020

REVISION DATES/NOTES  
00.00.2020

FILE LOCATION  
M:\

**SHOP DRAWING / SUBMITTAL REVIEW**

- APPROVED
- APPROVED WITH CHANGES NOTED
- REVISE / RESUBMIT

Submittal was reviewed for design conformity and general conformance to contract documents only. The contractor is responsible for tolerance, clearance, quantities, fabrication processes and techniques of construction, coordination of their work with other trades and full compliance with contract documents.

BY: \_\_\_\_\_

DATE: \_\_\_\_\_

© Messenger Corp 2020. All artwork contained herein is the copyrighted property of Messenger Corporation and may not be used or displayed in any medium without prior consent or paid compensation of \$5000 per proposal page or \$5000 per product containing unlawfully acquired Messenger Corporation artwork. Messenger Corporation will retain any and all usage rights to Logos, Designs, and Artwork. Usage rights (Limited or Complete) may be purchased from Messenger Corporation for an additional charge.

MESSENGER  
37 South Hudson Street  
Seattle, Washington 98134  
206.623.4525  
messengercorp.com

PAGE

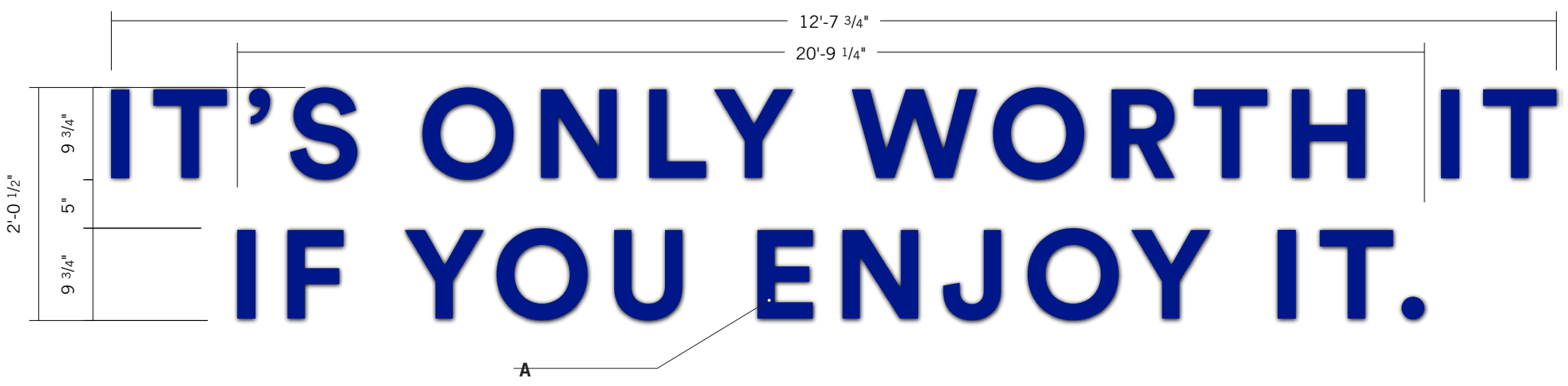

FRONT VIEW - IN.02

Scale: 3/4" = 1'- 0"

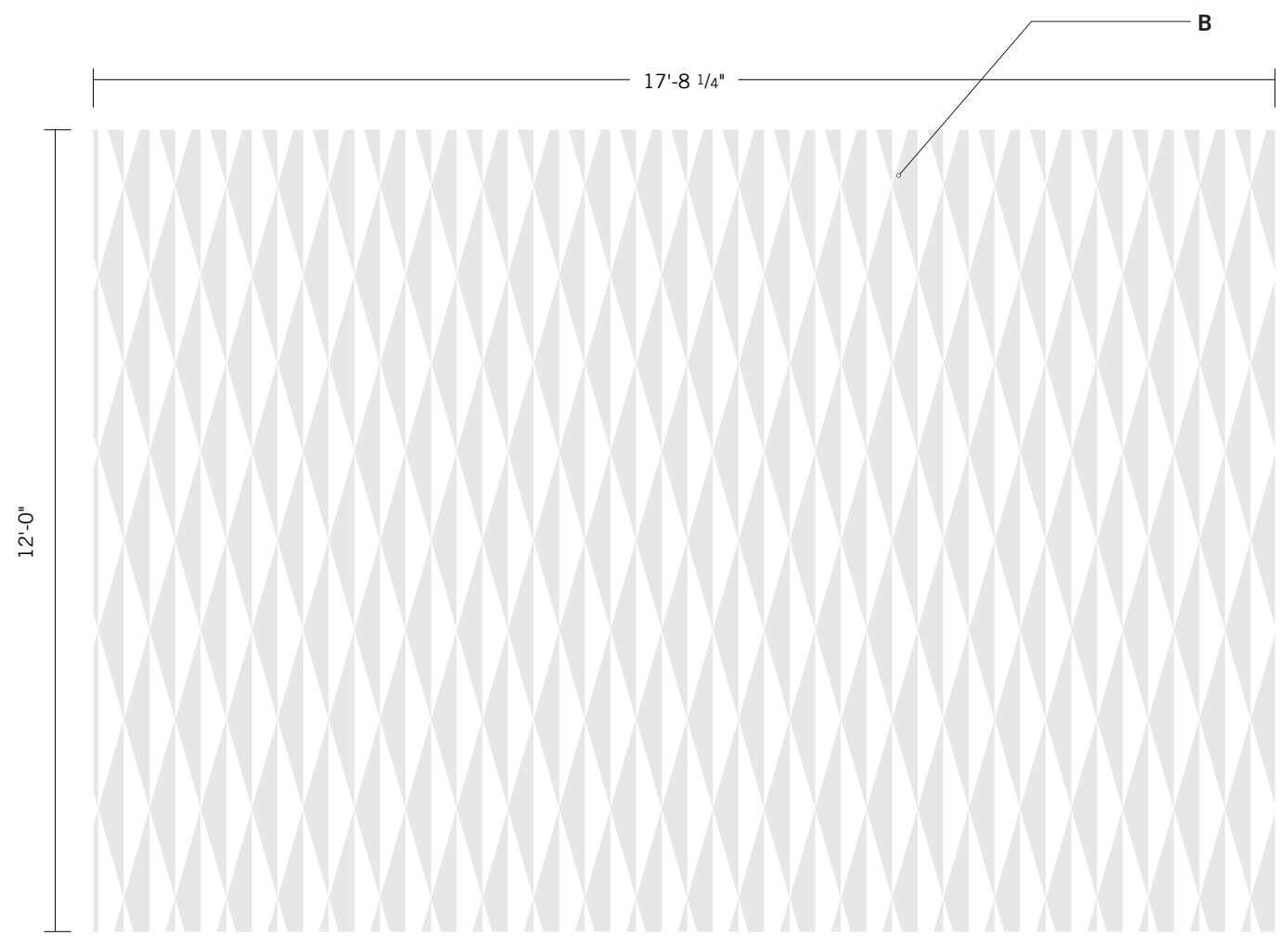

GRAPHIC PATTERN - FRONT VIEW - IN.02

Scale: 3/8" = 1'- 0"

**VERIFY** **SURVEY REQUIRED TO VERIFY:**

**EXISTING WALL DIMENSIONS**

**DETERMINE CONDITION OF EXISTING WALL FOR APPLICATION OF NEW GRAPHICS.**

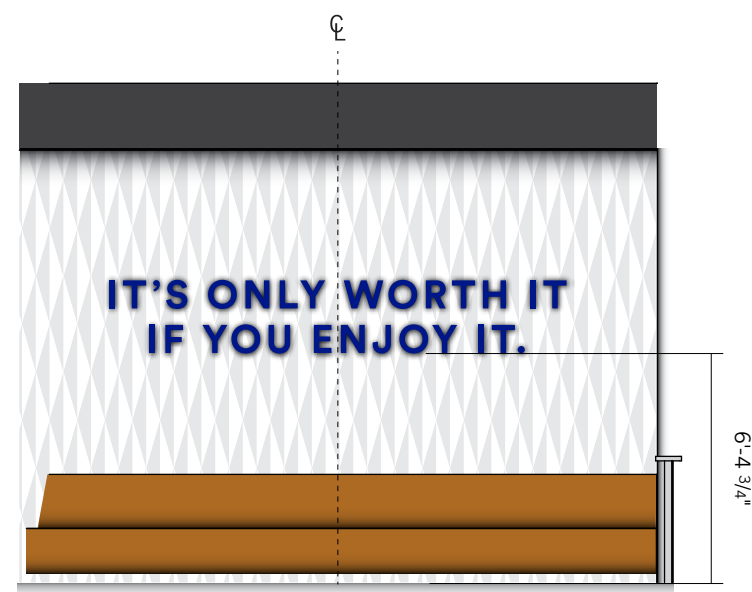

ELEVATION MOCKUP

Scale: 3/16" = 1'- 0"

**PMS REFLEX BLUE C**  
Satin Finish

**MICHELOB ULTRA - INTERIOR - CHESAPEAKE ENERGY ARENA**

SURVEY REQUIRED PRIOR TO PRODUCTION & INSTALL

**IN.03 - WEST INTERIOR WALL MESSAGE**

**MOUNTED TO EXISTING SOFFIT**

Total Qty: 1



JOB #  
**107034**

PROJECT NAME  
**Anheuser Bush - Michelob**

LOCATION  
**Chesapeake Energy Arena**

CONTACT  
**NA**

PROJECT MANAGER  
**NA**

DESIGN  
**NA**



ORIGINAL DATE  
**00.00.2020**

REVISION DATES/NOTES  
**00.00.2020**

FILE LOCATION  
**M:\**

**SHOP DRAWING / SUBMITTAL REVIEW**

- APPROVED
- APPROVED WITH CHANGES NOTED
- REVISE / RESUBMIT

Submittal was reviewed for design conformity and general conformance to contract documents only. The contractor is responsible for tolerance, clearance, quantities, fabrication processes and techniques of construction, coordination of their work with other trades and full compliance with contract documents.

BY: \_\_\_\_\_

DATE: \_\_\_\_\_

© Messenger Corp 2020. All artwork contained herein is the copyrighted property of Messenger Corporation and may not be used or displayed in any medium without prior consent or paid compensation of \$5000 per proposal page or \$5000 per product containing unlawfully acquired Messenger Corporation artwork. Messenger Corporation will retain any and all usage rights to Logos, Designs, and Artwork. Usage rights (Limited or Complete) may be purchased from Messenger Corporation for an additional charge.

MESSENGER  
37 South Hudson Street  
Seattle, Washington 98134  
206.623.4525  
messengercorp.com

PAGE

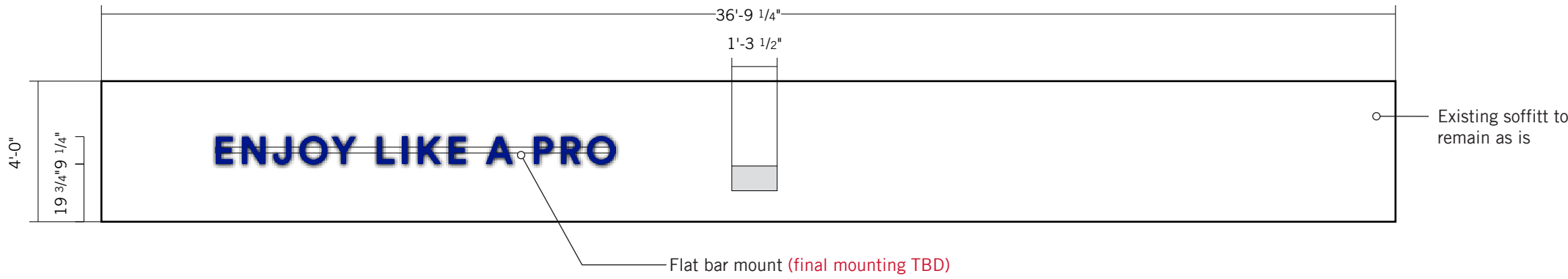

SIGN FRONT VIEW

Scale: 1/4" = 1'- 0"

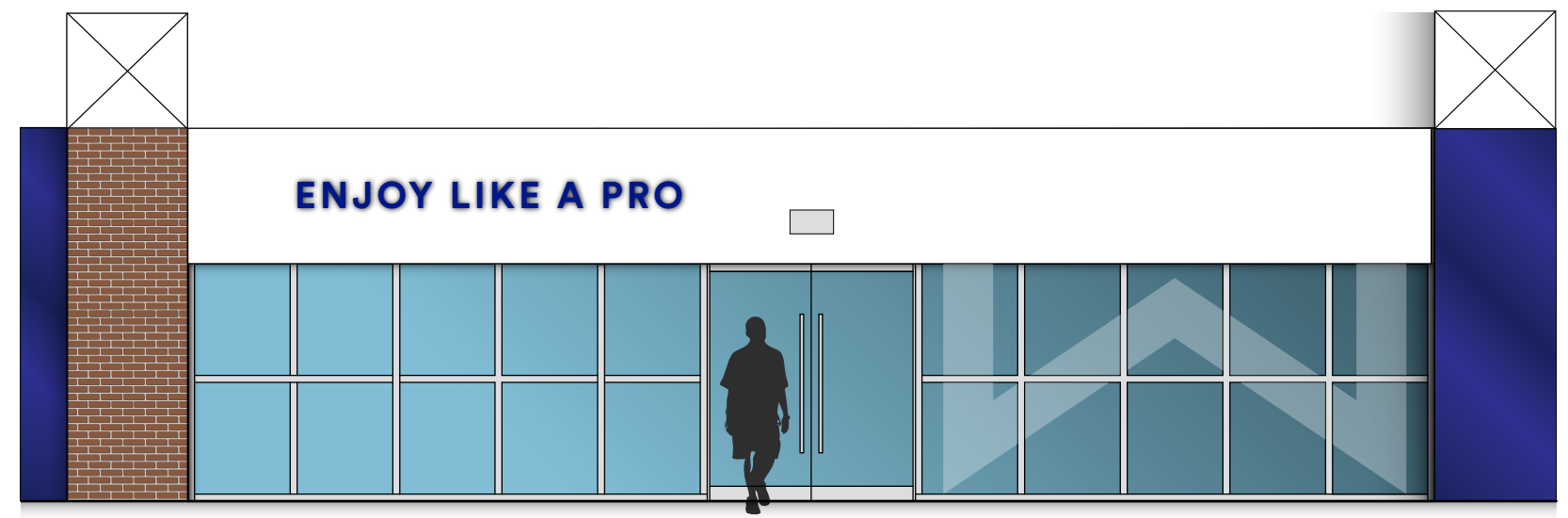

ELEVATION MOCKUP

Scale: 3/16" = 1'- 0"



CONCOURSE - PLAN NORTHEAST ENTRY AREA

Scale: NTS

**MICHELOB ULTRA - INTERIOR - CHESAPEAKE ENERGY ARENA**

SURVEY REQUIRED PRIOR TO PRODUCTION & INSTALL

**IN 04 - EAST INTERIOR BAR OKC WALL  
APPLIED TO WALL**

Total Qty: 1



JOB #  
**10734**

PROJECT NAME  
**Anheuser Bush**

LOCATION  
**Chesapeake Energy Arena**

CONTACT  
**NA**

PROJECT MANAGER  
**NA**

DESIGN  
**NA**

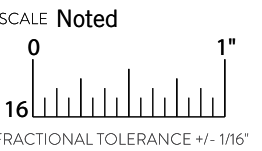

ORIGINAL DATE  
**00.00.2020**

REVISION DATES/NOTES  
**00.00.2020**

FILE LOCATION  
**M:\**

**SHOP DRAWING / SUBMITTAL REVIEW**

- APPROVED
- APPROVED WITH CHANGES NOTED
- REVISE / RESUBMIT

Submittal was reviewed for design conformity and general conformance to contract documents only. The contractor is responsible for tolerance, clearance, quantities, fabrication processes and techniques of construction, coordination of their work with other trades and full compliance with contract documents.

BY: \_\_\_\_\_

DATE: \_\_\_\_\_

© Messenger Corp 2020. All artwork contained herein is the copyrighted property of Messenger Corporation and may not be used or displayed in any medium without prior consent or paid compensation of \$5000 per proposal page or \$5000 per product containing unlawfully acquired Messenger Corporation artwork. Messenger Corporation will retain any and all usage rights to Logos, Designs, and Artwork. Usage rights (Limited or Complete) may be purchased from Messenger Corporation for an additional charge.

MESSENGER  
37 South Hudson Street  
Seattle, Washington 98134  
206.623.4525  
messengercorp.com

PAGE



GRAPHIC PATTERN - FRONT VIEW - IN.02

Scale: 3/4" = 1'- 0"

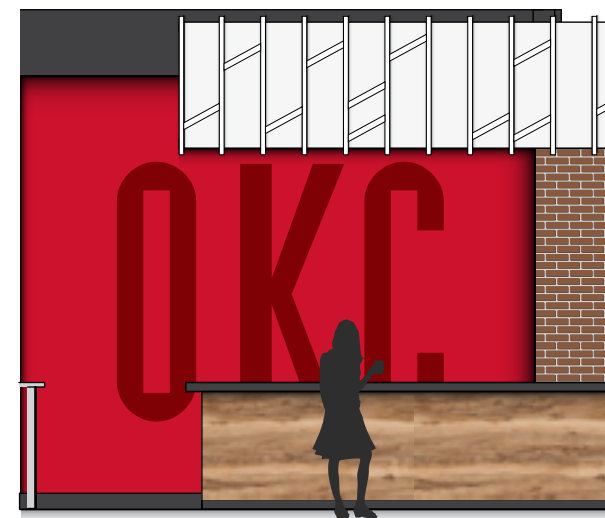

ELEVATION MOCKUP

Scale: 1/4" = 1'- 0"

**PMS 186 C**  
Satin Finish

**OKC RED TBD**  
Satin Finish

**MICHELOB ULTRA - EXTERIOR - CHESAPEAKE ENERGY ARENA**

SURVEY REQUIRED PRIOR TO PRODUCTION & INSTALL

**IN.06 - BAR COLLUMN MICHELOB SIGNS  
PIN MOUNTED TO WALL**

Total Qty: 2 (1 OF EACH)



JOB #  
**107034**

PROJECT NAME  
Anheuser Bush - MICHELOB

LOCATION  
South Philadelphia Sports Complex

CONTACT  
NA

PROJECT MANAGER  
NA

DESIGN  
NA

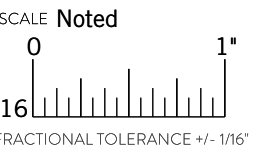

ORIGINAL DATE  
00.00.2020

REVISION DATES/NOTES  
00.00.2020

FILE LOCATION  
M:\

**SHOP DRAWING / SUBMITTAL REVIEW**

- APPROVED
- APPROVED WITH CHANGES NOTED
- REVISE / RESUBMIT

Submittal was reviewed for design conformity and general conformance to contract documents only. The contractor is responsible for tolerance, clearance, quantities, fabrication processes and techniques of construction, coordination of their work with other trades and full compliance with contract documents.

BY: \_\_\_\_\_

DATE: \_\_\_\_\_

© Messenger Corp 2020. All artwork contained herein is the copyrighted property of Messenger Corporation and may not be used or displayed in any medium without prior consent or paid compensation of \$5000 per proposal page or \$5000 per product containing unlawfully acquired Messenger Corporation artwork. Messenger Corporation will retain any and all usage rights to Logos, Designs, and Artwork. Usage rights (Limited or Complete) may be purchased from Messenger Corporation for an additional charge.

MESSENGER  
37 South Hudson Street  
Seattle, Washington 98134  
206.623.4525  
messengercorp.com

PAGE

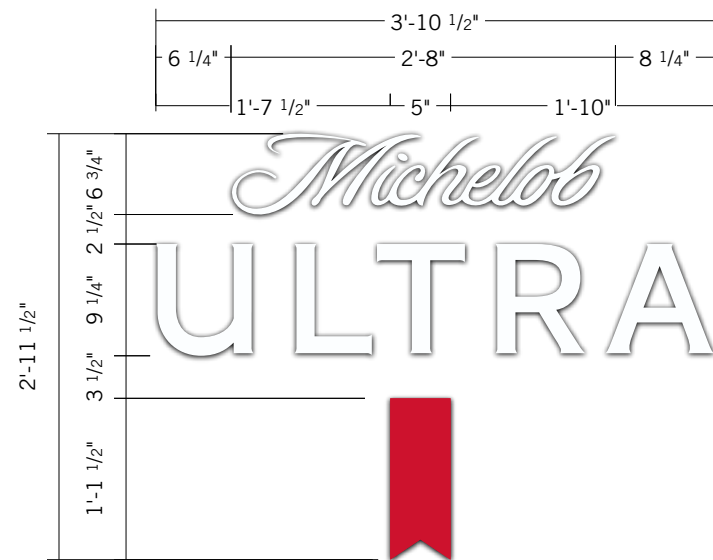

DIMENSIONAL WALL GRAPHIC MICHELOB

Scale: 3/4" = 1'- 0"

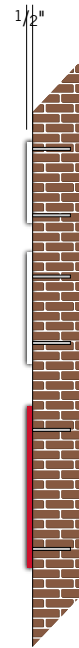

SIDE VIEW MICHELOB - IN 06.A

Scale: 3/4" = 1'- 0"

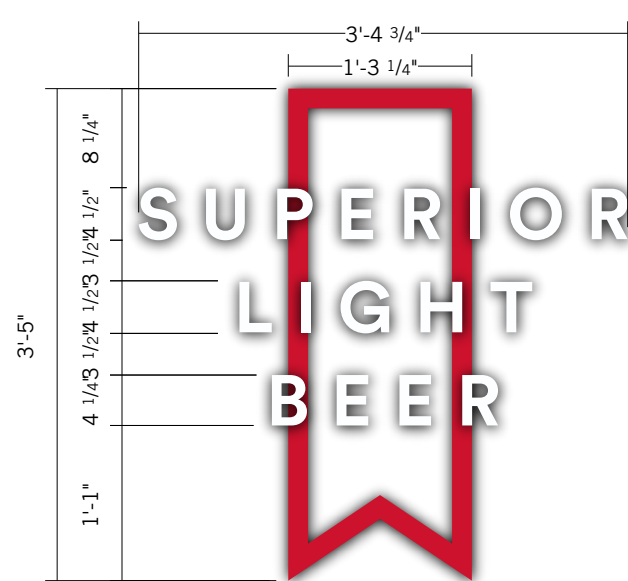

DIMENSIONAL WALL GRAPHIC RIBBON

Scale: 3/4" = 1'- 0"



SIDE VIEW RIBBON - IN 06.B

Scale: 3/4" = 1'- 0"

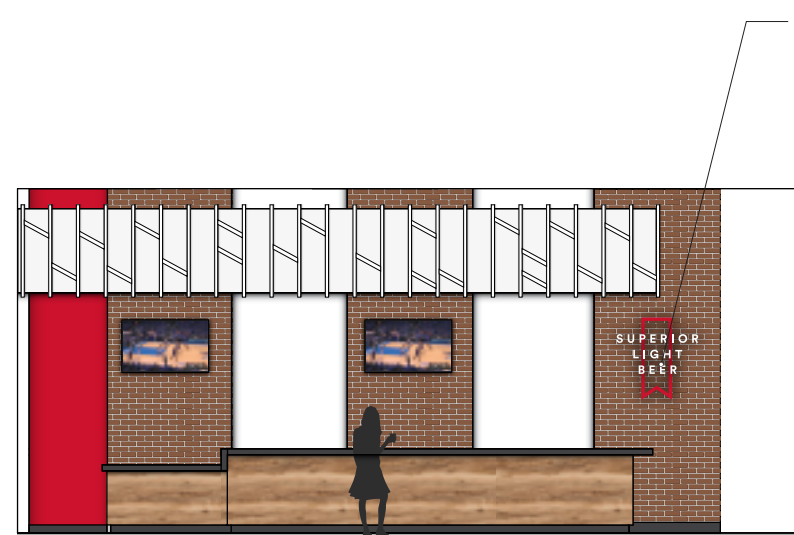

NORTH BAR WALL

Scale: 1/8" = 1'- 0"

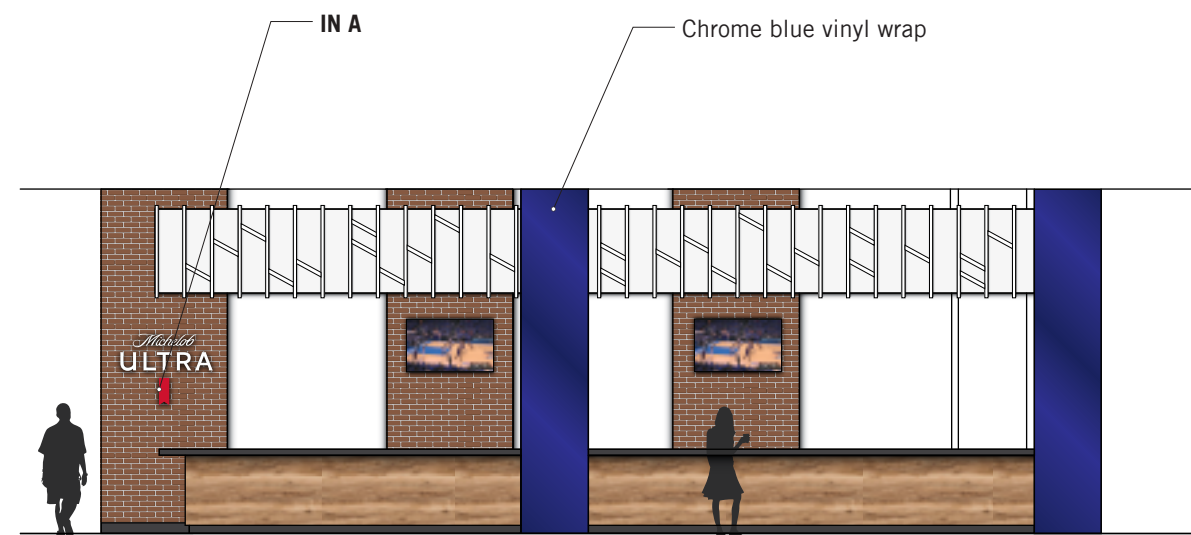

SOUTH BAR WALL

Scale: 1/8" = 1'- 0"

	White Matte Finish
--	-----------------------

	PMS 186 C Satin Finish
--	---------------------------

	3M 1080 Blue Chrome Vinyl
--	------------------------------



SURVEY REQUIRED PRIOR TO PRODUCTION & INSTALL

**IN.07 - HOSTESS WALL GRAPHIC Option 2**  
**APPLIED TO WALL**

Total Qty: 1

**A. WALL GRAPHICS**

Digital printed graphic onto wallpaper material with a satin finish.

**MOUNTING**

Graphic Pattern applied directly to wall



JOB #  
**107034**

PROJECT NAME  
**Anheuser Bush - MICHELOB**

LOCATION  
**South Philadelphia Sports Complex**

CONTACT  
**NA**

PROJECT MANAGER  
**NA**

DESIGN  
**NA**

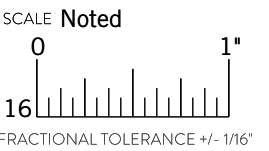

ORIGINAL DATE  
**00.00.2020**

REVISION DATES/NOTES  
**00.00.2020**

FILE LOCATION  
**M:\**

**SHOP DRAWING / SUBMITTAL REVIEW**

- APPROVED
- APPROVED WITH CHANGES NOTED
- REVISE / RESUBMIT

Submittal was reviewed for design conformity and general conformance to contract documents only. The contractor is responsible for tolerance, clearance, quantities, fabrication processes and techniques of construction, coordination of their work with other trades and full compliance with contract documents.

BY: \_\_\_\_\_

DATE: \_\_\_\_\_

© Messenger Corp 2020. All artwork contained herein is the copyrighted property of Messenger Corporation and may not be used or displayed in any medium without prior consent or paid compensation of \$5000 per proposal page or \$5000 per product containing unlawfully acquired Messenger Corporation artwork. Messenger Corporation will retain any and all usage rights to Logos, Designs, and Artwork. Usage rights (Limited or Complete) may be purchased from Messenger Corporation for an additional charge.

MESSINGER  
 37 South Hudson Street  
 Seattle, Washington 98134  
 206.623.4525  
 messengercorp.com

PAGE

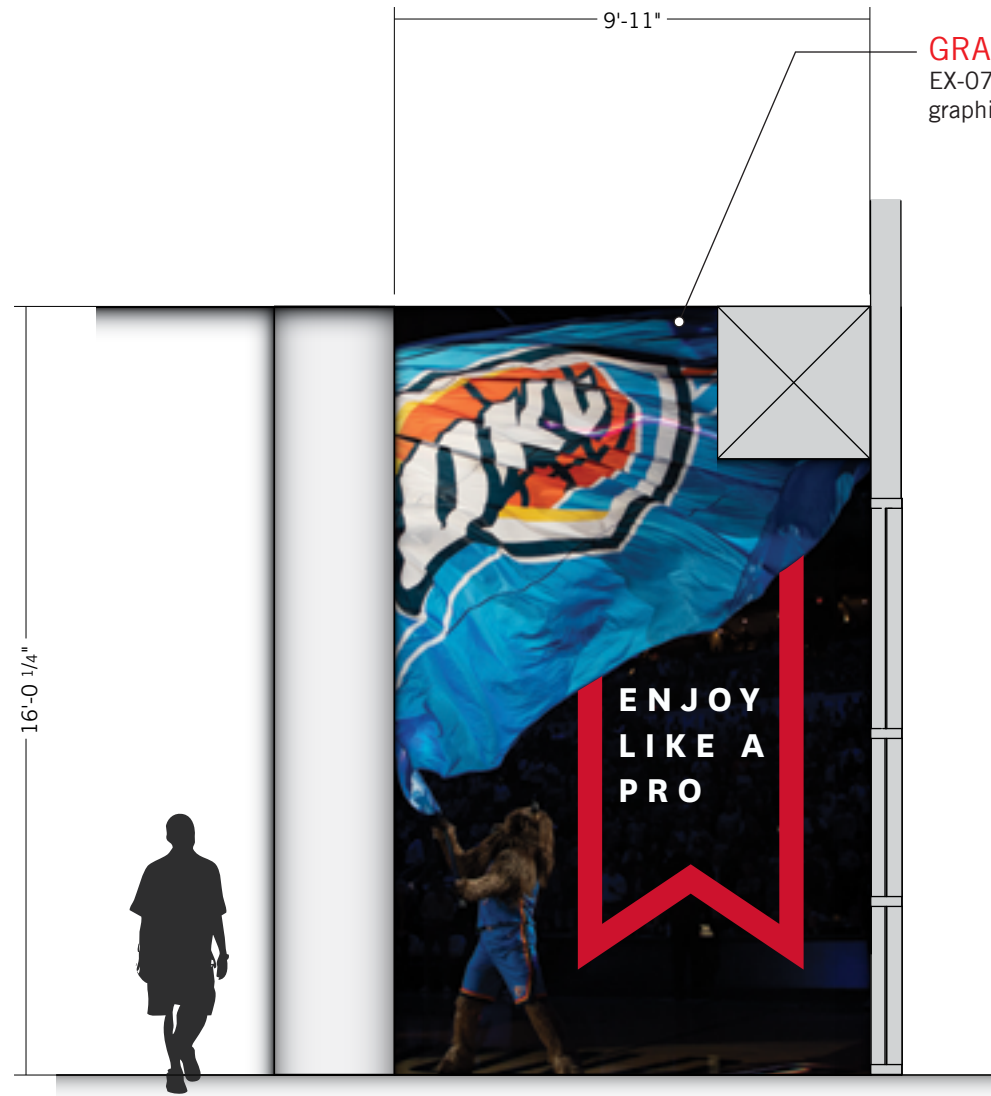

**GRAPHIC OPTION 2**  
 EX-07: Digitally printed wallpaper graphic of Fan Centric image

HOSTESS WALL

Scale: 1/4" = 1'- 0"

White  
 Matte Finish

PMS 186 C  
 Satin Finish

3M 1080  
 Blue Chrome Vinyl

**messenger** **SPORTS**

**ANHEUSER-BUSCH**

