



Anheuser-Busch

BUDLIGHT SELTZER SESSIONS | CONTAINER BAR

FOREST HILLS STADIUM
Queens, New York

07.20.2022

messenger **SPORTS**

NEW YORK | SEATTLE | SAN DIEGO

CURRENT CONDITIONS

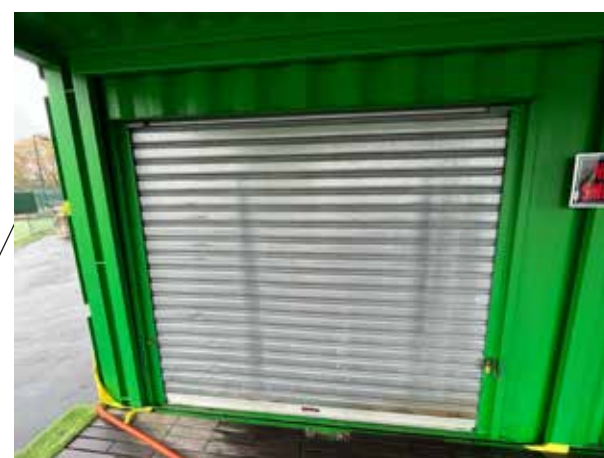
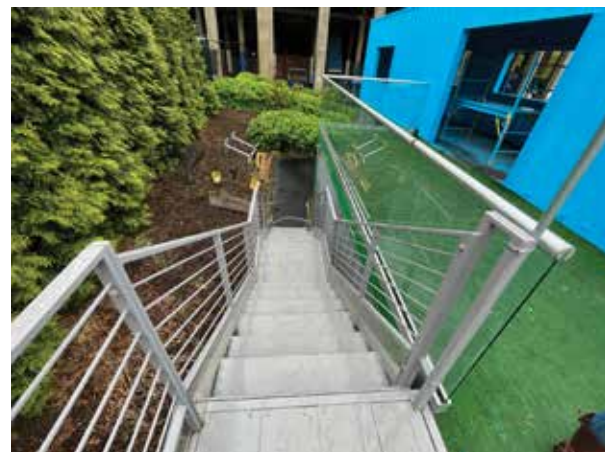

SIGN PLAN - TOP FLOOR

- EX.01 BLS Illuminated Main ID
- EX.02 BLS Dimensional Blade Sign
- EX.03 BLS Illuminated Secondary ID
- EX.04 BLS & LFE Railing Graphics
- EX.05 Forest Hills Feature Wall
- EX.06 BLS Rolling Bar
- EX.13 BLS LFE Flags
- IN.01 BLS PMS Acrylic Blade Light Feature
- IN.02 Dimensional LFE Bar Sign
- IN.03 "Be Loud Queens" Wall Graphics
- IN.04 Screen Printing station Backer
- IN.04.1 Screen Printing Cabinetry
- IN.11 Digitally Printed Cut Cans

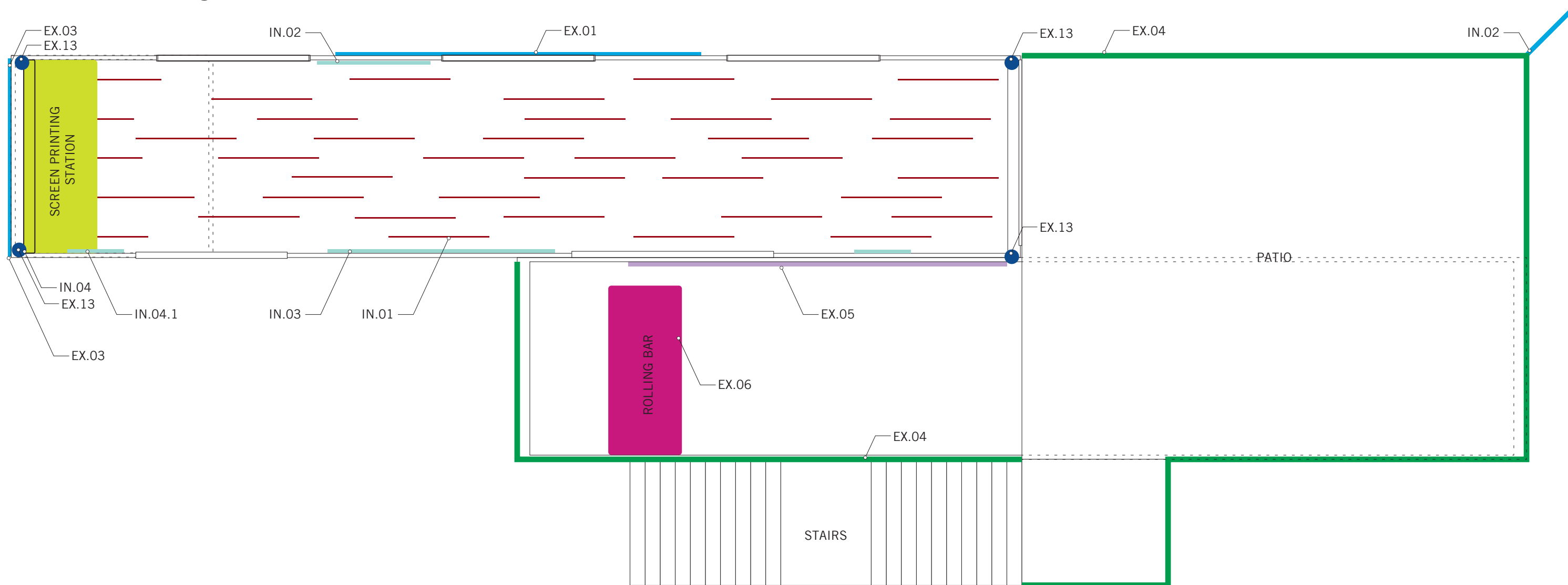

PLAN VIEW - UPPER LEVEL

Scale: 1/4" = 1'- 0"

SIGN PLAN - BOTTOM FLOOR

- EX.01 BLS Illuminated Main ID
- EX.08-08.2 BLS Contrainer Wrap
- EX.09 BLS Entry "Forest Hill" Wall
- EX.10 BLS Photobooth
- EX.11 Forest Hills Feature Wall
- EX.12 BLS Poster Frame
- IN.05 BLS PMS Glow Light Feature
- IN.06 BLS Bar Stations
- IN.07 BLS Bar Backer
- IN.08 Screen Printing station Backer
- IN.09 Screen Printing Cabinetry
- IN.10 Bar Menus and Shelves

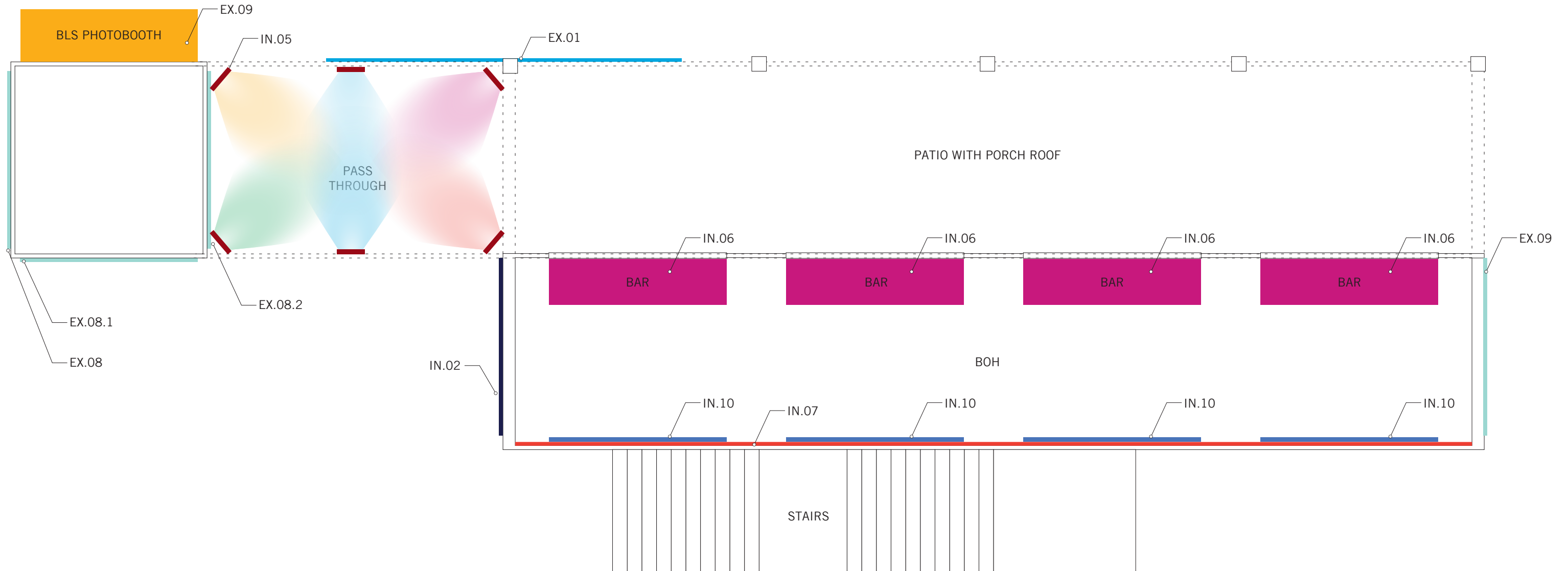

PLAN VIEW - LOWER LEVEL

Scale: 1/4" = 1'- 0"

RENDER DRAWINGS

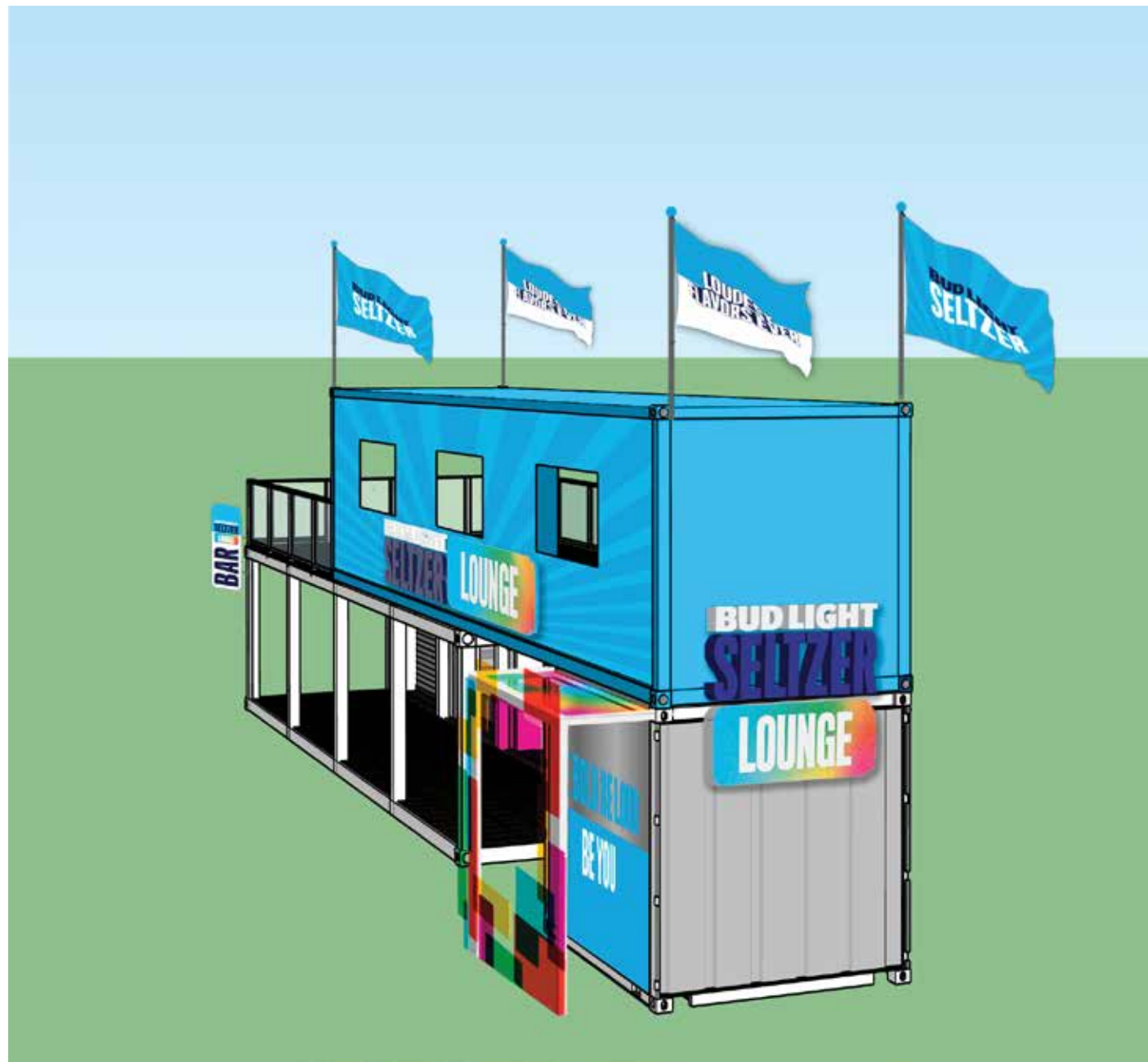

BLS - CONTAINER BAR - RENDER 3/4 VIEW RIGHT

Scale: NTS

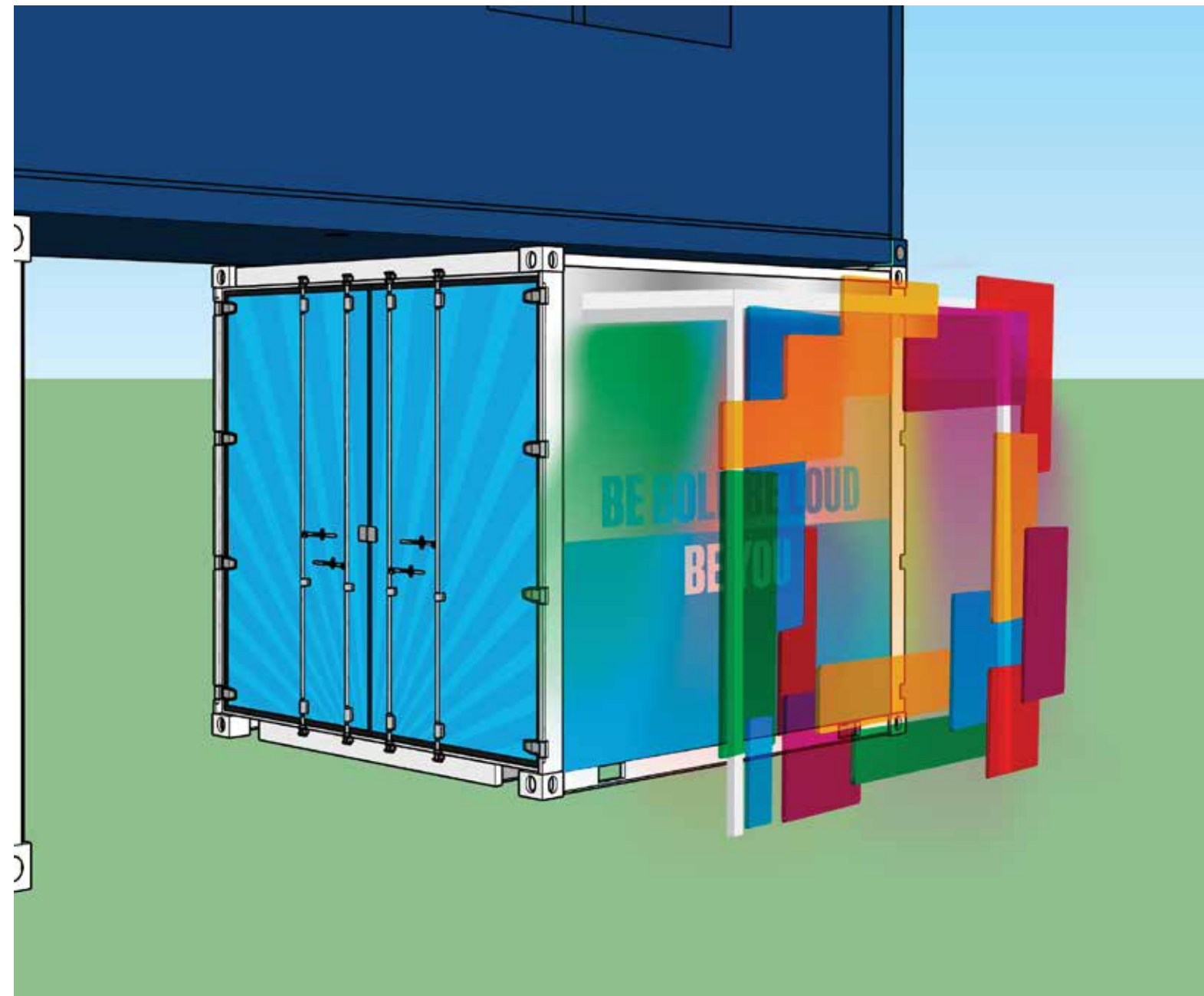

BLS - INSTAGRAM PHOTOBOOTH - RENDER 3/4 VIEW LEFT

Scale: NTS

ELEVATION - FRONT

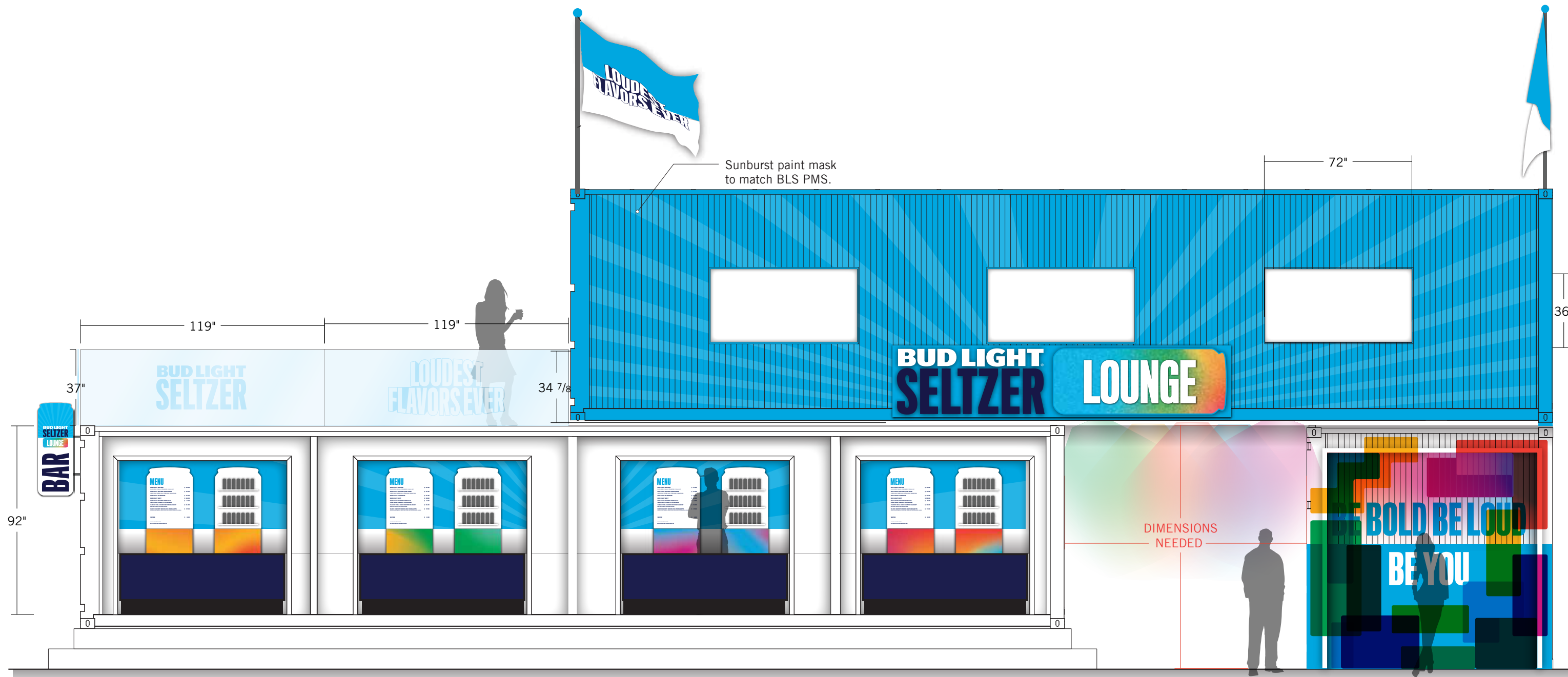

ELEVATION

Scale: 1/4" = 1'- 0"

EX.01 BLS ILLUMINATED MAIN ID - DETAIL

DESIGN APPROVED
FOR PRODUCTION

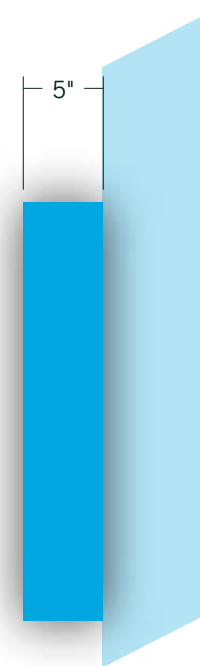

EX.01 - DIMENSIONAL MAIN ID

Scale: 3/4" = 1'- 0"

DIMENSIONAL BLADE SIGN - SIDE VIEW

Scale: 1" = 1'- 0"

	Pantone 2995 C BM 2060-40 Toronto Blue
	Pantone 2985 C BM 2060-50 Cayman Blue
	Pantone 2766 BM 2065-10 Admiral Blue
	White

EX.01.1 BLS ILLUMINATED MAIN ID - DETAIL

DESIGN APPROVED
FOR PRODUCTION

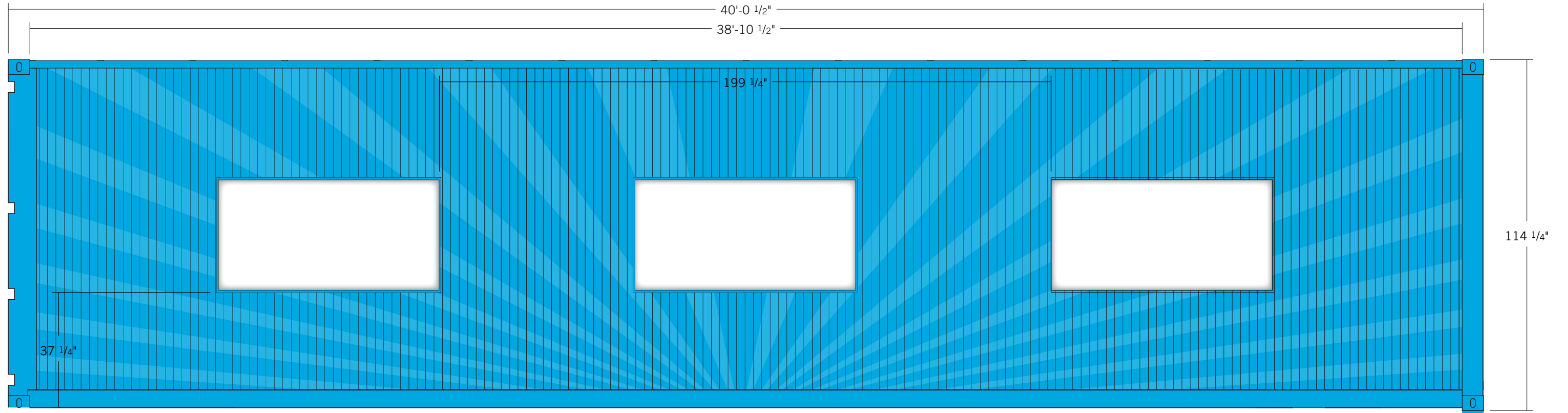

EX.01.1 - CONTAINER SUNBURST PAINTMASK - BOTH FRONT AND BACK

Scale: 1" = 1'- 0"

CONFIRM CORRUGATION IS MEASURED CORRECTLY 1.5" IS NOT THE HYPOTENUSE

CONFIRM ALL VERTICAL CORRUGATION MEASURES THE SAME ON ALL CONTAINERS. IF DIFFERENT PROVIDE SAME DIMENSIONS REQUESTED BELOW

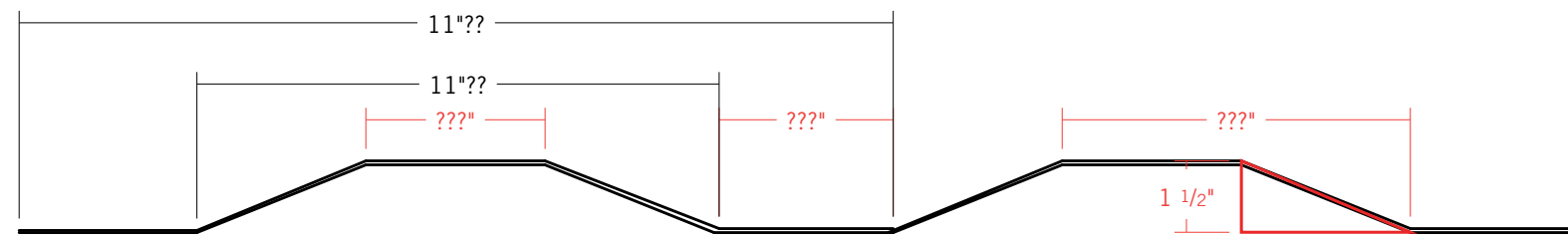

EX.01.1 - CORRUGATION CLARIFICATION

Scale: 3" = 1'- 0"

Pantone 2995 C BM 2060-40 Toronto Blue
Pantone 2985 C BM 2060-50 Cayman Blue
Pantone 2766 BM 2065-10 Admiral Blue
White

EX.02 BLS DIMENSIONAL BLADE SIGN - DETAIL

DESIGN APPROVED
FOR PRODUCTION

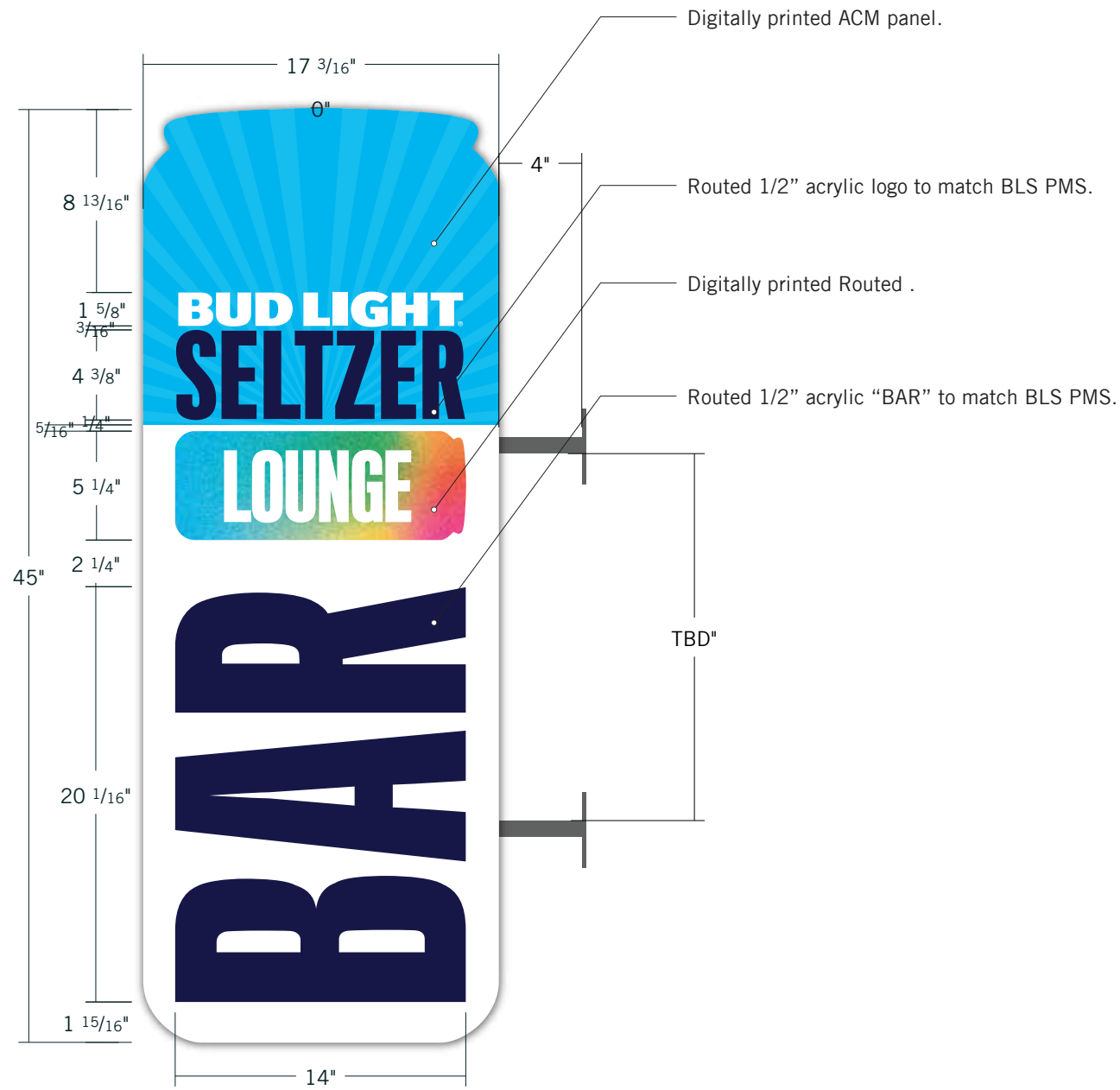

EX.02 - DIMENSIONAL BLADE SIGN

Scale: 1" = 1'- 0"

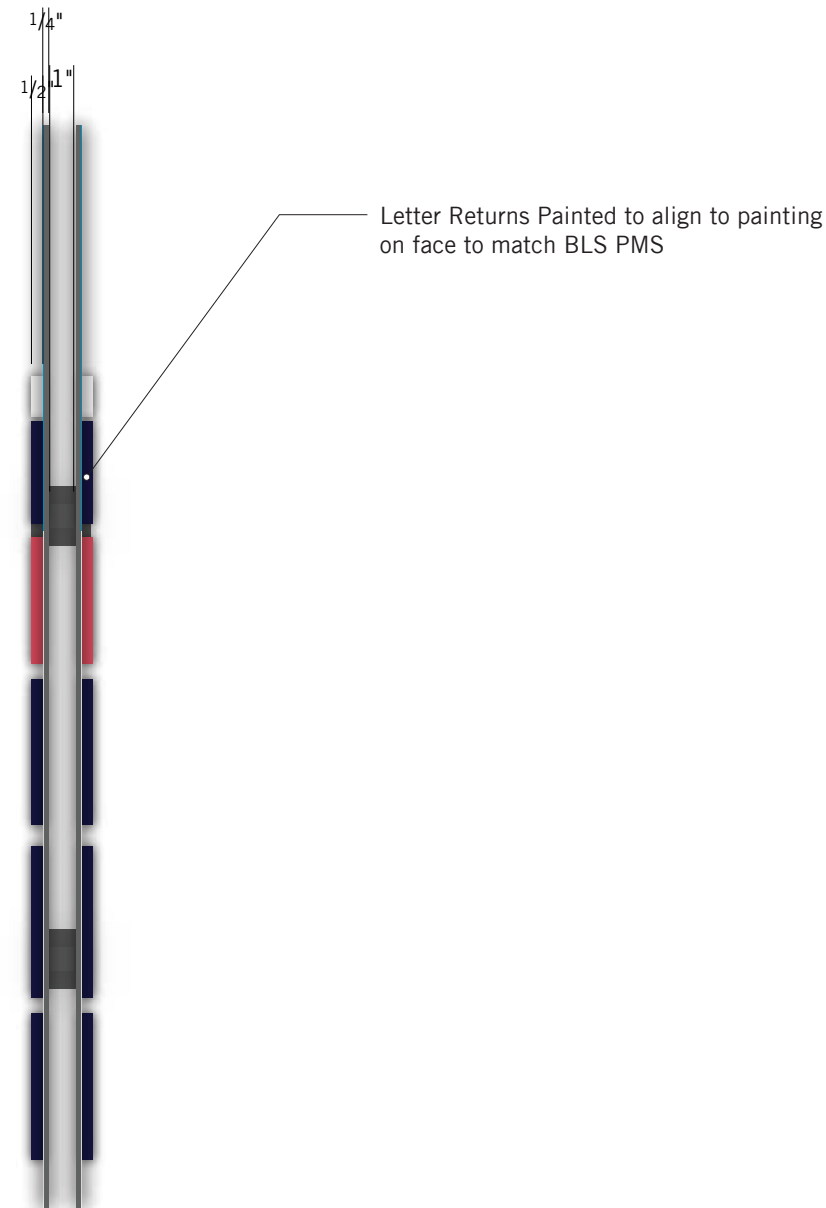

EX.02 - DIMENSIONAL BLADE SIGN - SIDE VIEW

Scale: 1" = 1'- 0"

Pantone 2995 C BM 2060-40 Toronto Blue
Pantone 2985 C BM 2060-50 Cayman Blue
Pantone 2766 BM 2065-10 Admiral Blue
White

IN.06 BLS BAR STATIONS & IN.07 BLS BAR BACKER - DETAIL

DESIGN APPROVED
FOR PRODUCTION

CONFIRM INTERIOR
CONTAINER MEASUREMENTS

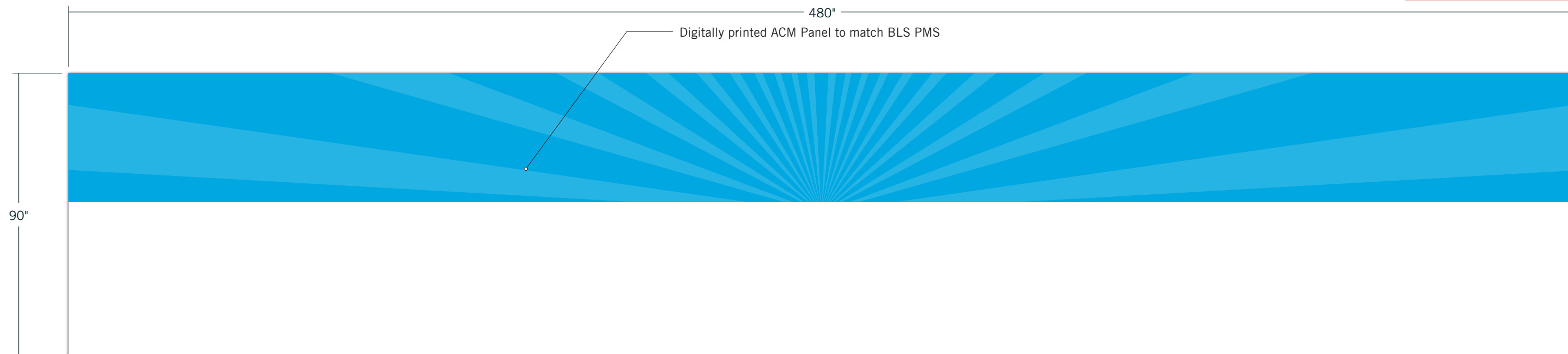

IN.07 - DETAIL

Scale: 3/8" = 1'- 0"



IN.06 - BAR STATIONS

Scale: 3/4" = 1'- 0"

Pantone 2995 C
BM 2060-40 Toronto Blue

Pantone 2985 C
BM 2060-50 Cayman Blue

Pantone 2766
BM 2065-10 Admiral Blue

White

IN.07 BLS BAR BACKER & IN.10 BAR MENUS AND SHELVES

DESIGN APPROVED
FOR PRODUCTION

CONFIRM INTERIOR
CONTAINER MEASUREMENTS

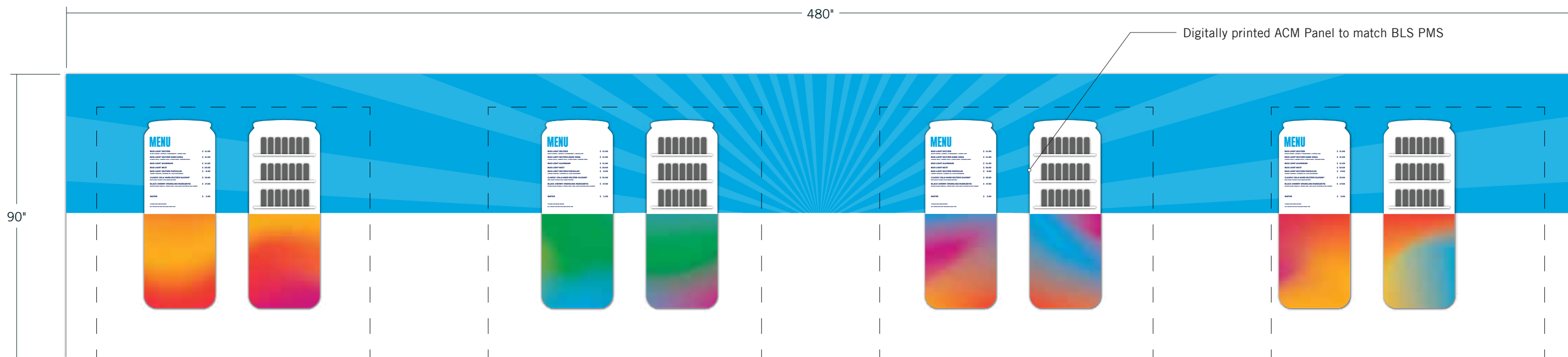

IN.07 - DETAIL

Scale: 3/8" = 1'-0"

Pantone 2995 C
BM 2060-40 Toronto Blue

Pantone 2985 C
BM 2060-50 Cayman Blue

White

IN.07 BLS BAR BACKER & IN.10 BAR MENUS AND SHELVES

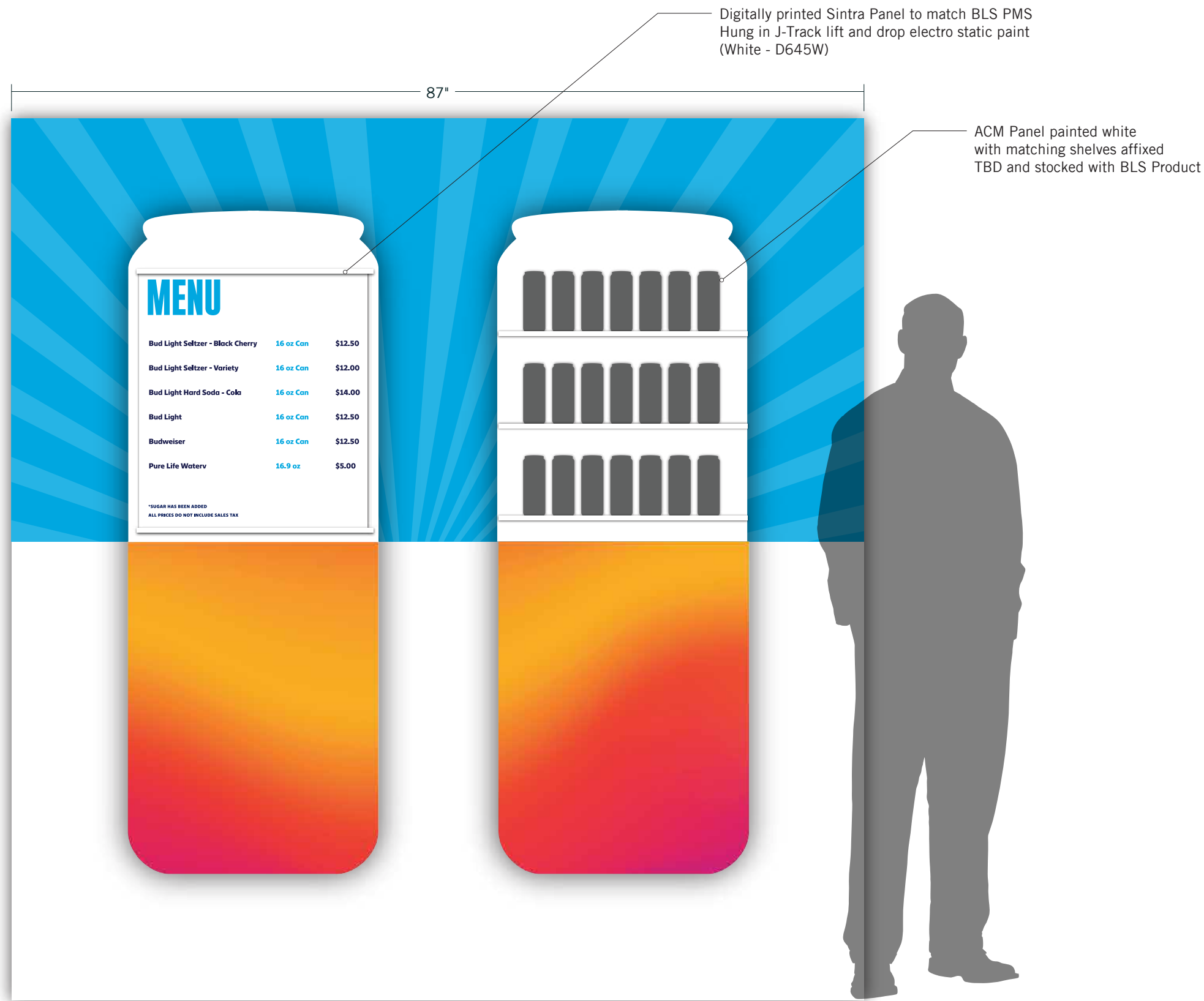

Pantone 7482 C BM 2033-20 Peppermint Leaf	Pantone 137 C BM 2018-10 Orange Sky
Pantone 2257 C BM 2032-30 Fresh Lime	Pantone 143 C BM 2018-40 Nacho Cheese
Pantone 3556 C BM 2012-13 Tawny Day Lily	Pantone 2995 C BM 2060-40 Toronto Blue
Pantone 2348 C BM 2012-30 Tangerine Dream	Pantone 2985 C BM 2060-50 Cayman Blue
Pantone 233 C BM 2077-30 Hot Lips	Pantone 2766 BM 2065-10 Admiral Blue
Pantone 2046 BM 2078-40 Hot Lips	White

IN.07 - BACK BAR

Scale: 1" = 1'- 0"

EX.10 BLS PHOTOBOOTH - FRONT VIEW - OPTION 1

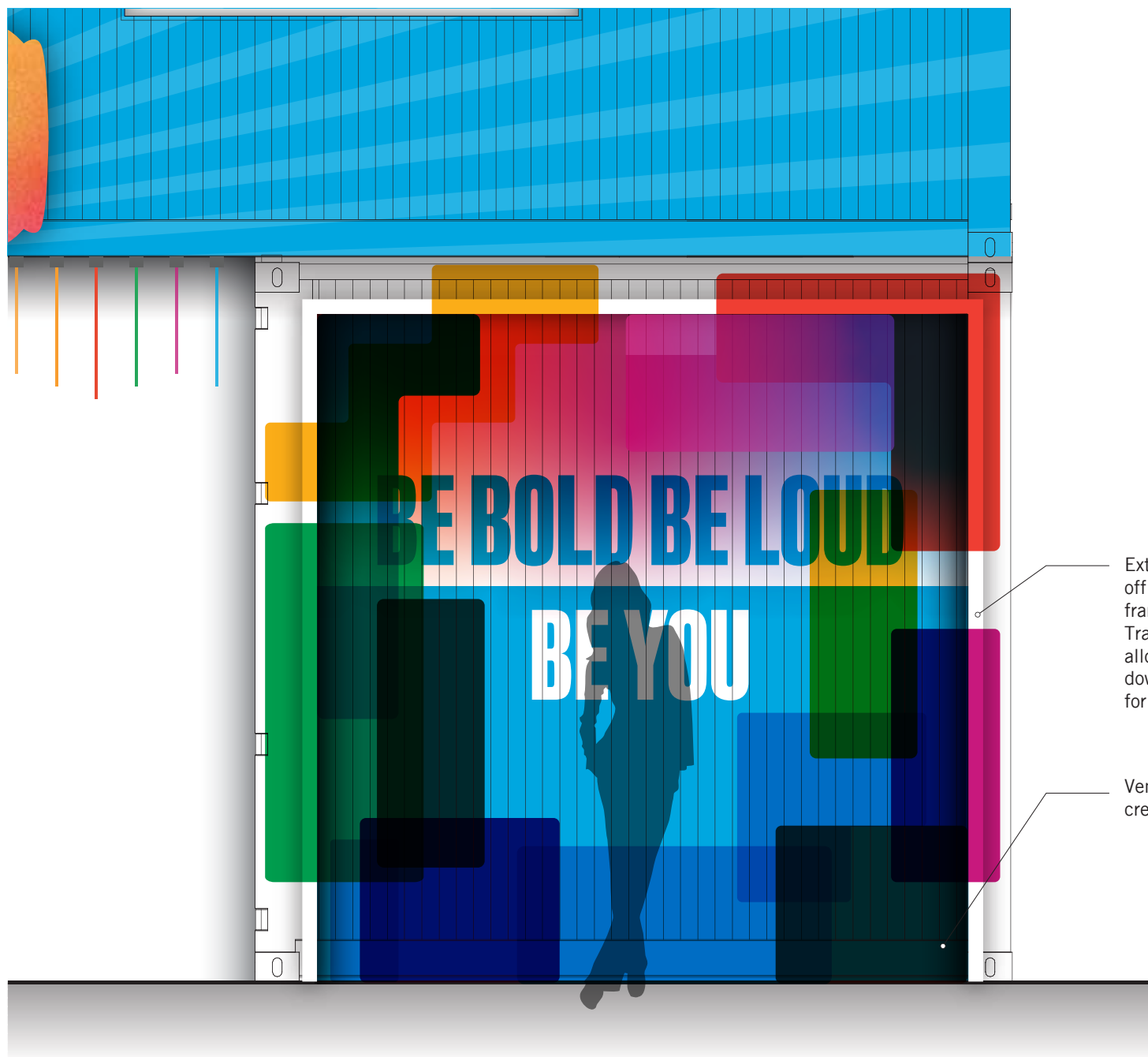

External Structure to built off of existing container and framing clear acrylic inset to frame Translucent/graded vinyl to allow sun/spotlights pointing downward to create colored lighting for Photo opportunities

Vents at bottom and top to create airflow inside photobooth





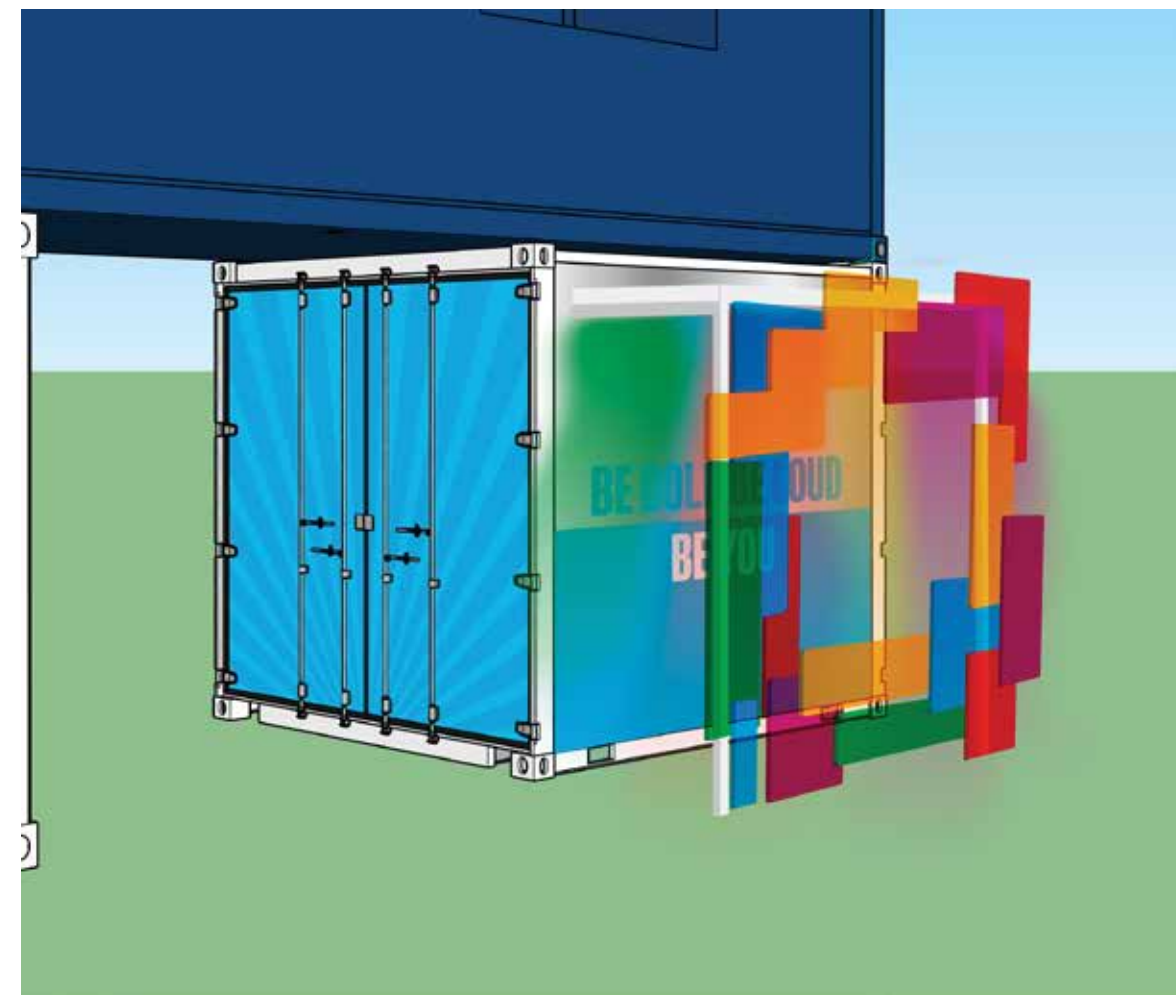

EX.10 - OPTION 1 - DETAIL

Scale: 1/2" = 1'- 0"



RENDER - INSTAGRAMMABLE MOMENT

Scale: NTS

 Pantone 137 C BM 2018-10 Orange Sky	 Pantone 2995 C BM 2060-40 Toronto Blue
 Pantone 7482 C BM 2033-20 Peppermint Leaf	 Pantone 2766 BM 2065-10 Admiral Blue
 Pantone 3556 C BM 2012-13 Tawny Day Lily	 White
 Pantone 233 C BM 2077-30 Hot Lips	

EX.10 BLS PHOTOBOOTH - SIDE VIEW - OPTION 1

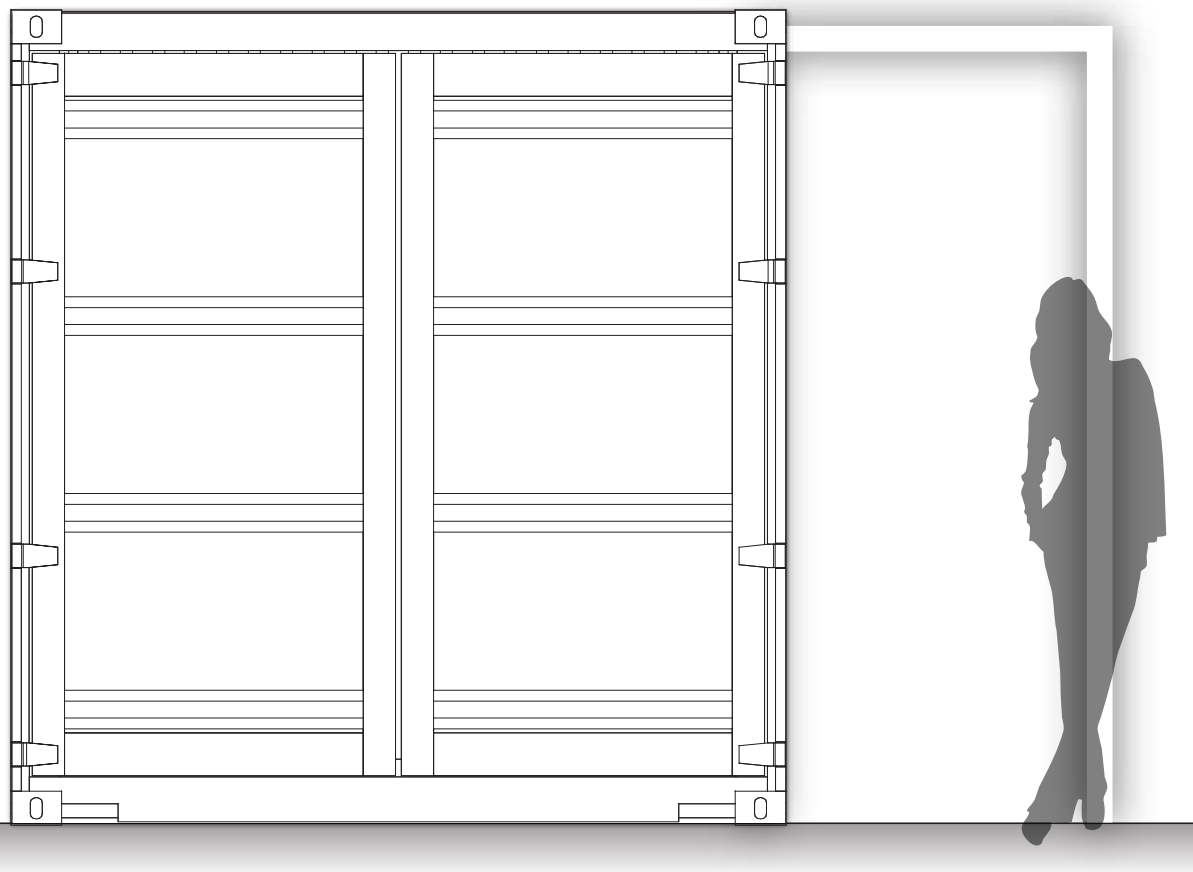

EX.10 - OPTION 1 - ELEVATION - SIDE VIEW - RIGHT

Scale: 1/2" = 1'- 0"



EX.10 - OPTION 1 - ELEVATION - SIDE VIEW - RIGHT

Scale: 1/2" = 1'- 0"

EX.10 BLS PHOTOBOOTH - DETAIL - OPTION 1

Translucent Vinyl wrapped in digitally printed translucent gradient wrap to match BLS PMS. Light Bars/spot lights shine downward through to create gradiated colorful lighting.



EX.10.1 - OPTION 1 - ACRYLIC LAYOUT ON PHOTOBOOTH

Scale: 1/2" = 1'- 0"

Left Side Open For entry

External Structure to built off of existing container and for mounting clear colored acrylic.



EX.10 - OPTION 1 - DETAIL - ACRYLIC LAYOUT ON PHOTOBOOTH

Scale: 1/2" = 1'- 0"

OPTION 1

**BE BOLD
BE LOUD
BE YOU**

OPTION 2

**HARD SELTZER
EASY LIVING**

OPTION 3

**FLAVOR YOUR
VIBE /LIFE**

OPTION 4

**AS BOLD
AS YOU**

OPTION 5

**WHATS YOUR
FLAVOR?**

MARKETING TAGLINE CTA OPTIONS

Scale: NTS

CONFIRM CORRUGATION IS MEASURED CORRECTLY 1.5" IS NOT THE HYPOTENUSE

CONFIRM ALL VERTICAL CORRUGATION MEASURES THE SAME ON ALL CONTAINERS. IF DIFFERENT PROVIDE SAME DIMENSIONS REQUESTED BELOW

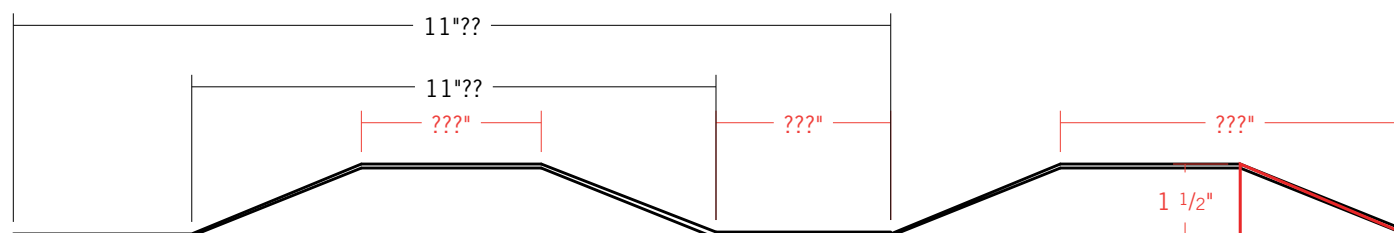

EX.01.1 - CORRUGATION CLARIFICATION

Scale: 3" = 1'- 0"

BE BOLD BE LOUD

BE YOU

CONFIRM MEASUREMENTS SPECIAL MOUNT VINYL or PAINT WRAP OVER CORRUGATION

Vinyl Wrap Or paint mask applied directly to container surface.

EX.10.2 - OPTION 1 - DETAIL - ACRYLIC LAYOUT ON PHOTOBOOTH

Scale: 1/2" = 1'- 0"



Intended Lighting Affect

Scale: NTS

EX.10 BLS PHOTOBOOTH - FRONT VIEW - OPTION 2



Decorated with hanging plants

External Structure to built off of existing container of steel and steel mesh. Ceiling is inset and framed with clear acrylic wrapped in translucent/graded vinyl to allow sun/spotlights pointing downward to create colored lighting for Photo opportunities

Face Illuminated Be Bold Text fastened to back of cage.

19"x19" Cubes Constructed out of steel and steel mesh. Open Bottom to allow for plants and other decorative elements to be placed inside.

LED Light Bars Intermingled with tropical greenery. Adds to lighting effect. Adhered to steel mesh.



Intended Affect

Scale: NTS

EX.10 - OPTION 2 - DETAIL

Scale: 1/2" = 1'- 0"

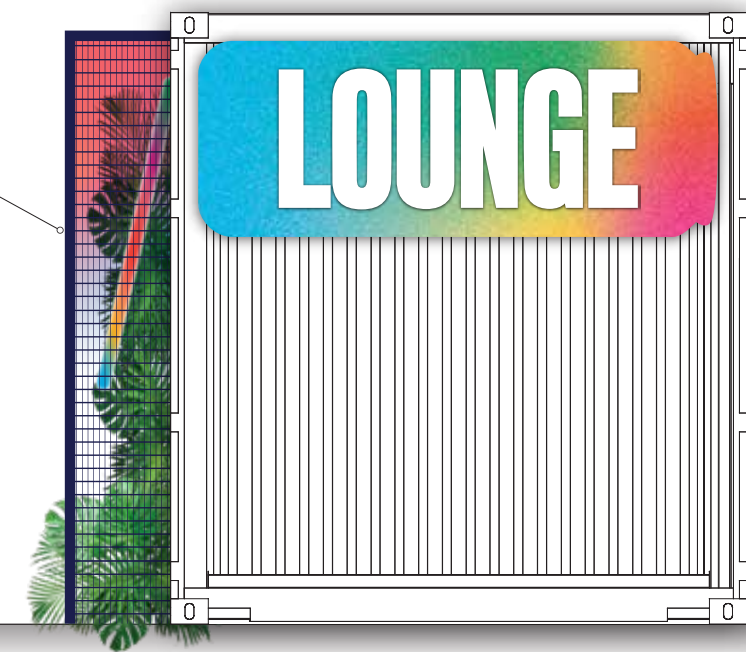

ELEVATION - SIDE VIEW

Scale: 3/8" = 1'- 0"

IN.05 BLS PMS GLOW LIGHT FEATURE - PLAN VIEW & DETAIL

DESIGN APPROVED
FOR PRODUCTION

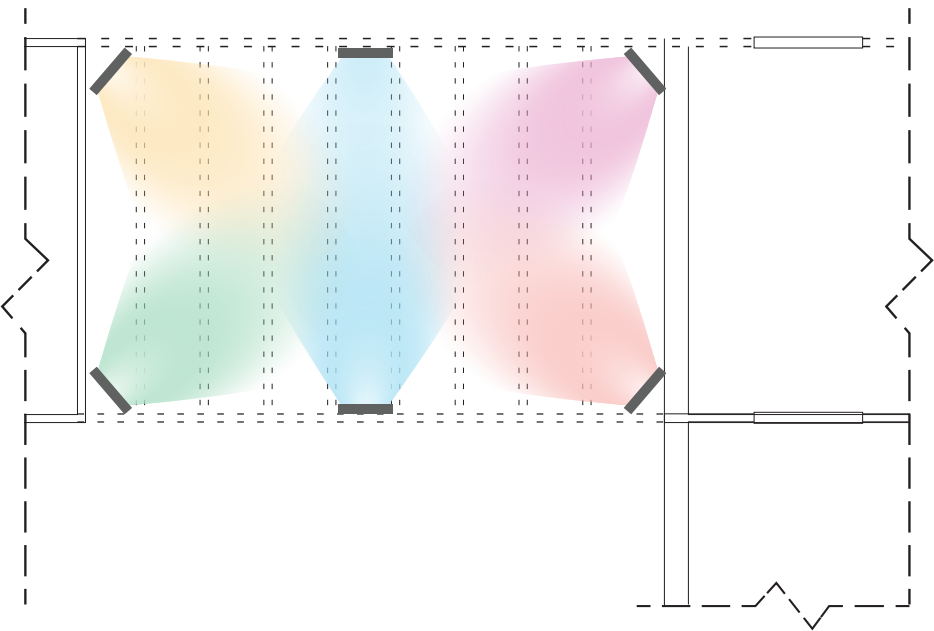

IN.05 - PLAN VIEW - LOWER LEVEL

Scale: 1/4" = 1'- 0"

RGB LED Spot lights are hung from rafters* creating BLS PMS colored light glow under passthrough.

* Lights hung above base of rafters to avoid swinging container doors pictured Below.

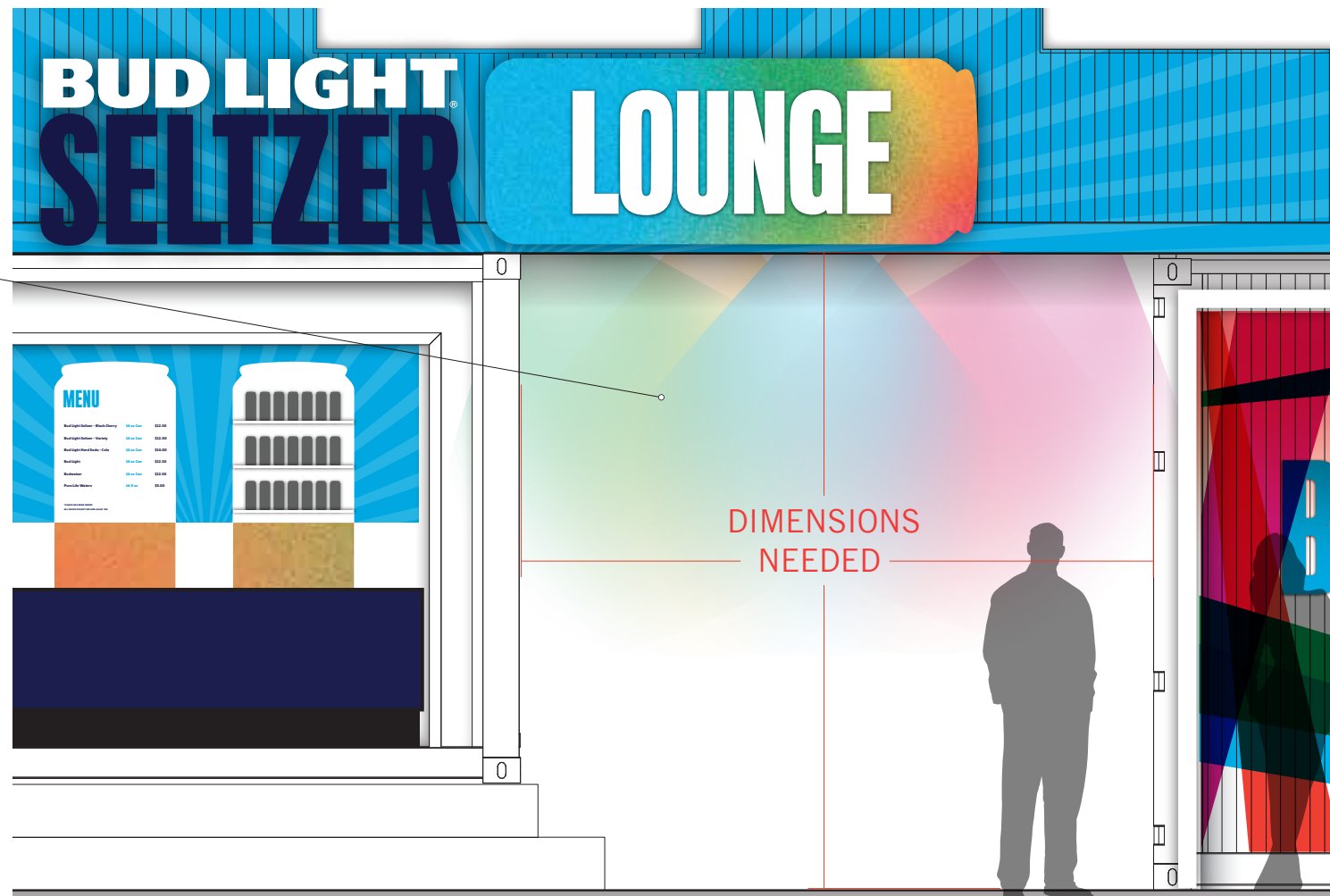

IN.05 - ELEVATION

Scale: 3/8" = 1'- 0"



CURRENT CONDITIONS

Scale: NTS



MIBOXER RGB+TUNABLE WHITE - 120V - 6000 LUMENS

<https://www.superbrightleds.com/moreinfo/landscape-spot-flood-lights/60w-smart-led-flood-light-fixture-milight-miboxer-rgbtunable-white-120v-6000-lumens/6645/>

Pantone 7482 C BM 2033-20 Peppermint Leaf	Pantone 137 C BM 2018-10 Orange Sky
Pantone 2257 C BM 2032-30 Fresh Lime	Pantone 143 C BM 2018-40 Nacho Cheese
Pantone 3556 C BM 2012-13 Tawny Day Lily	Pantone 2995 C BM 2060-40 Toronto Blue
Pantone 2348 C BM 2012-30 Tangerine Dream	Pantone 2985 C BM 2060-50 Cayman Blue
Pantone 233 C BM 2077-30 Hot Lips	Pantone 2766 BM 2065-10 Admiral Blue
Pantone 2046 BM 2078-40 Hot Lips	White

RENDER DRAWINGS

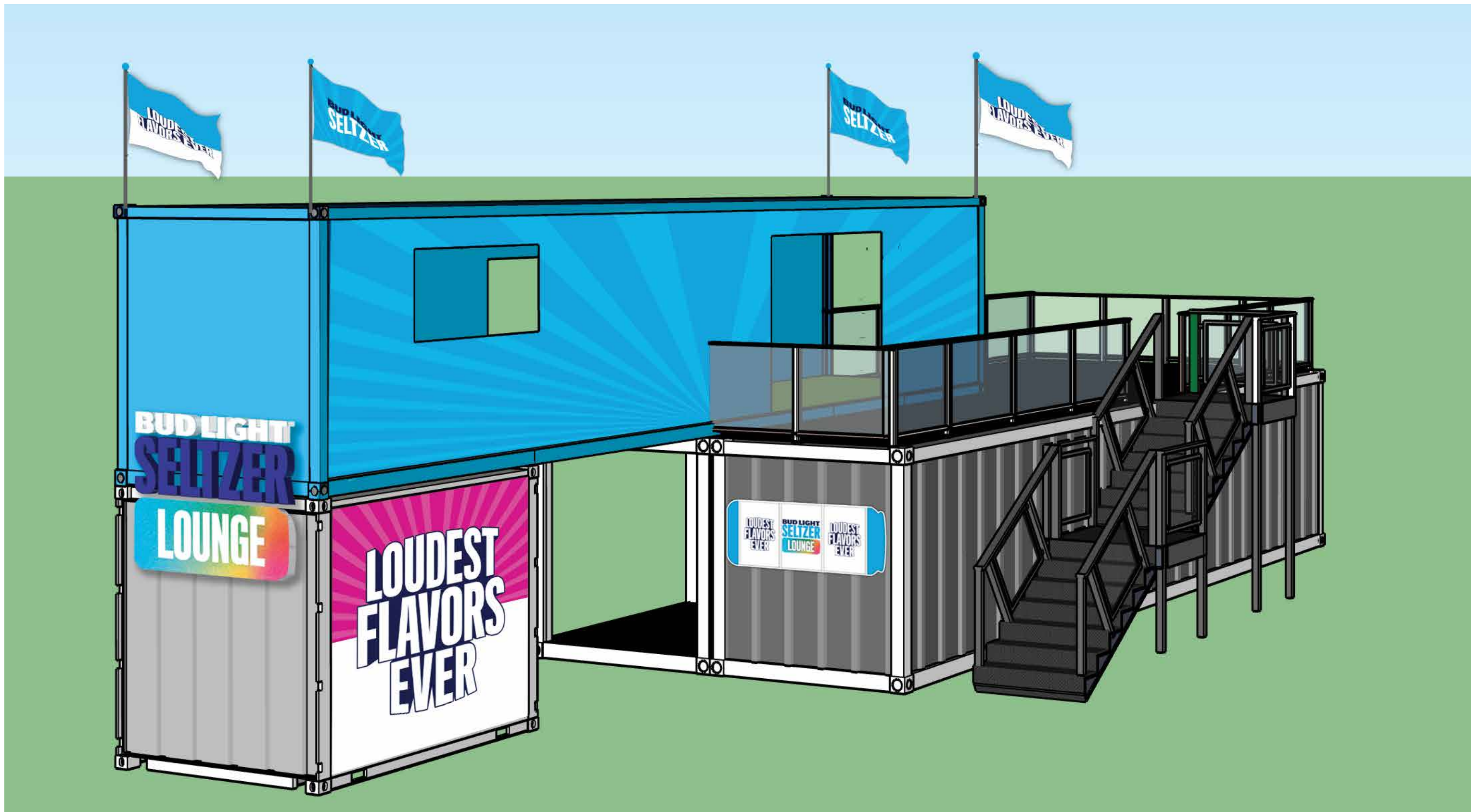

RENDER DRAWING - REAR LEFT 3/4 VIEW - FOR APPEARANCE ONLY

Scale: 1/4" = 1'-0"

ELEVATION - RIGHT SIDE & BANNISTER DETAIL

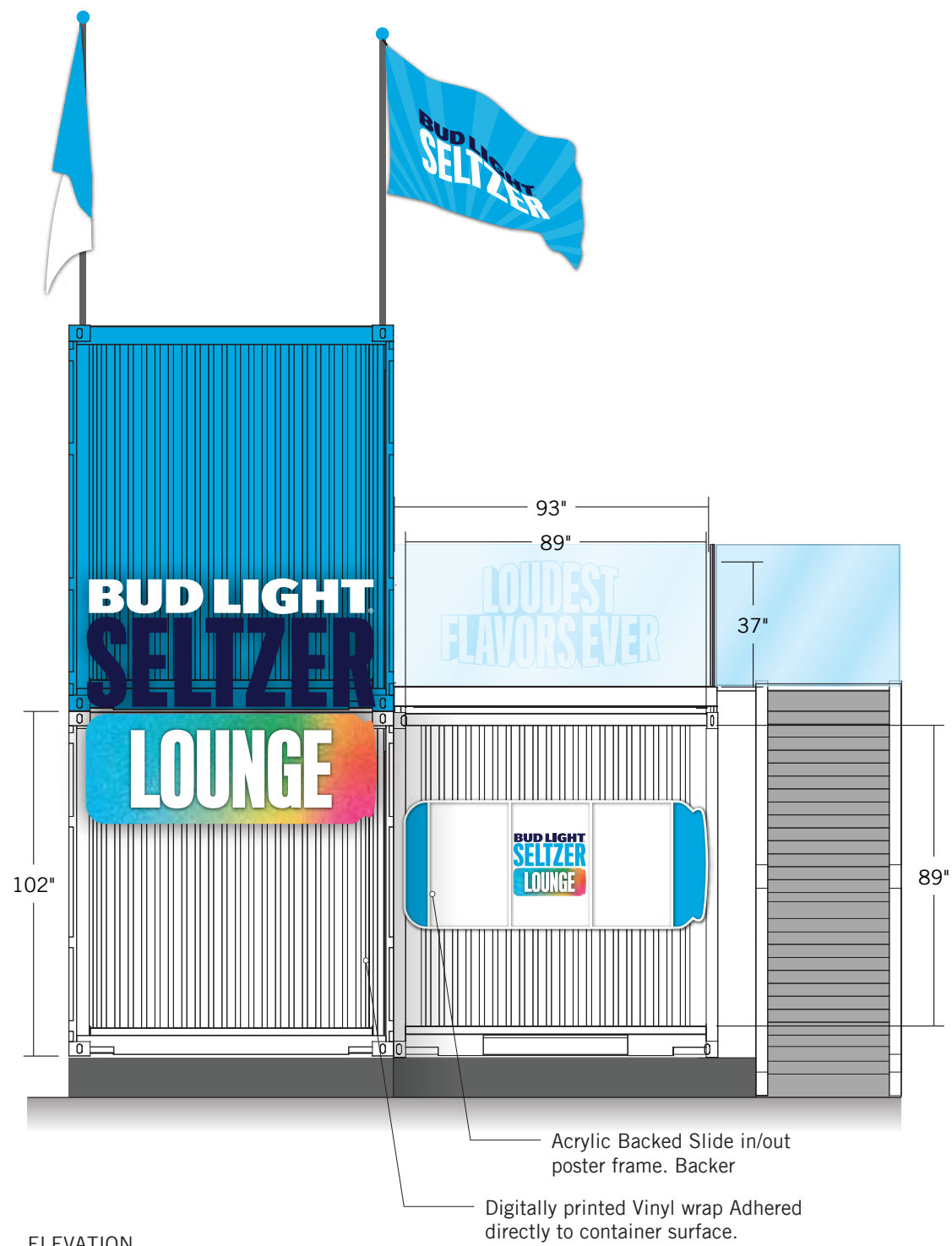

ELEVATION

Scale: 1/4" = 1'- 0"

EX.03 BLS ILLUMINATED SECONDARY ID

DESIGN APPROVED
FOR PRODUCTION

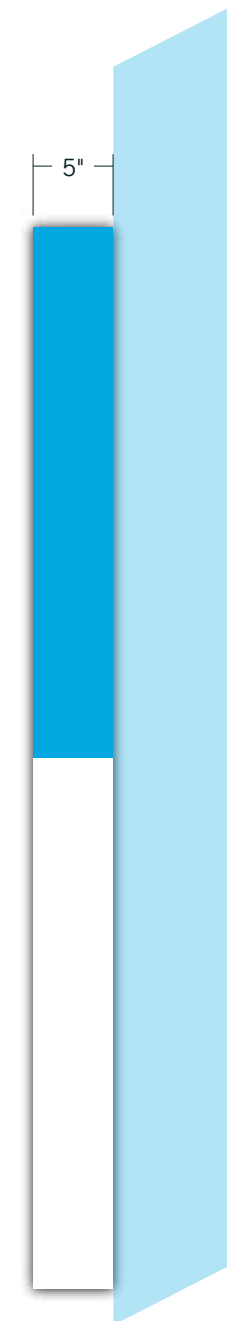
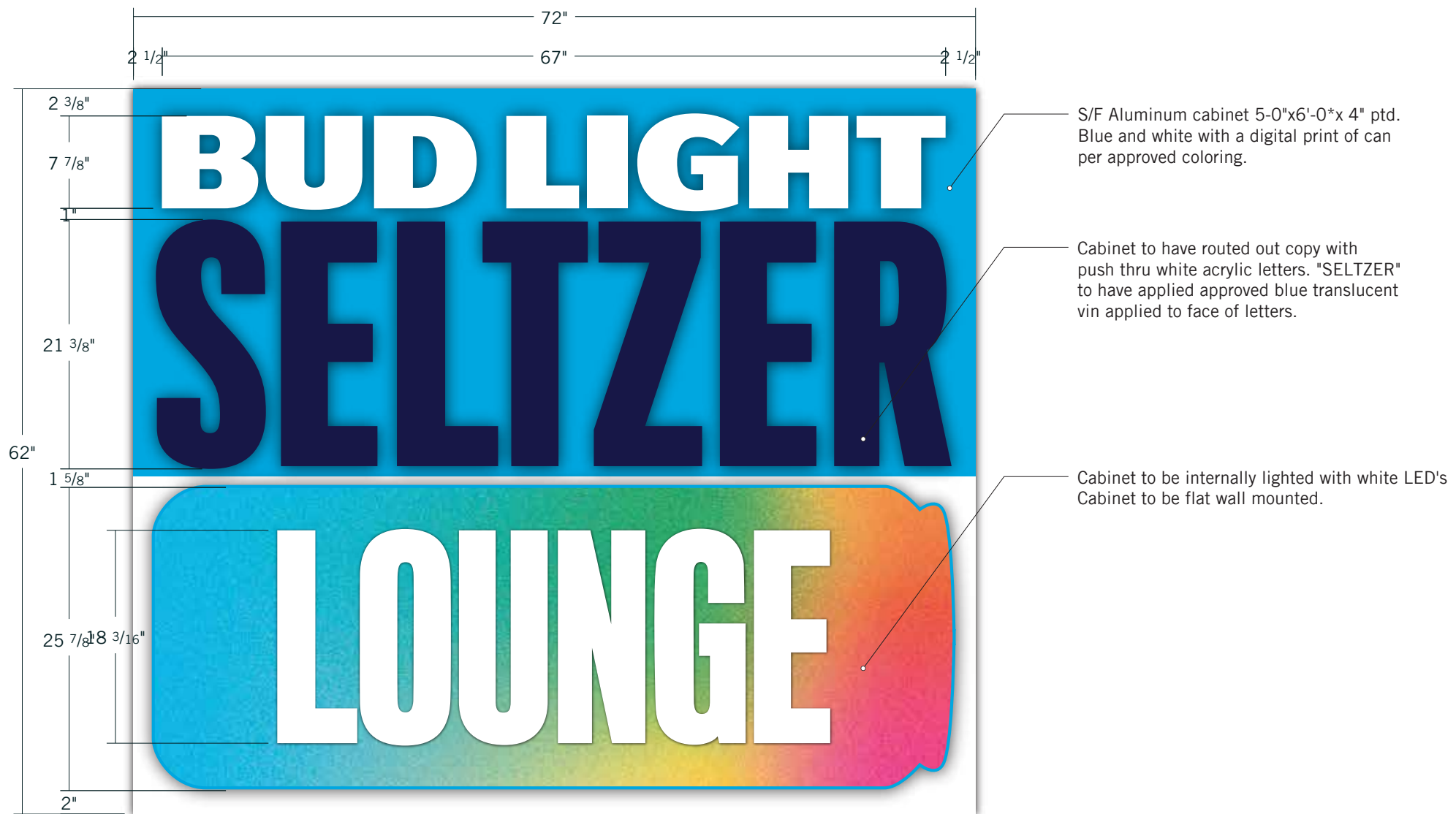

DETAIL - BLS CAN POSTER FRAME

Scale: 1" = 1'- 0"

DETAIL - BLS CAN POSTER FRAME

Scale: 1" = 1'- 0"

Pantone 2985 C BM 2060-50 Cayman Blue
Pantone 2766 BM 2065-10 Admiral Blue
White

EX.12 BLS POSTER FRAME - DETAIL

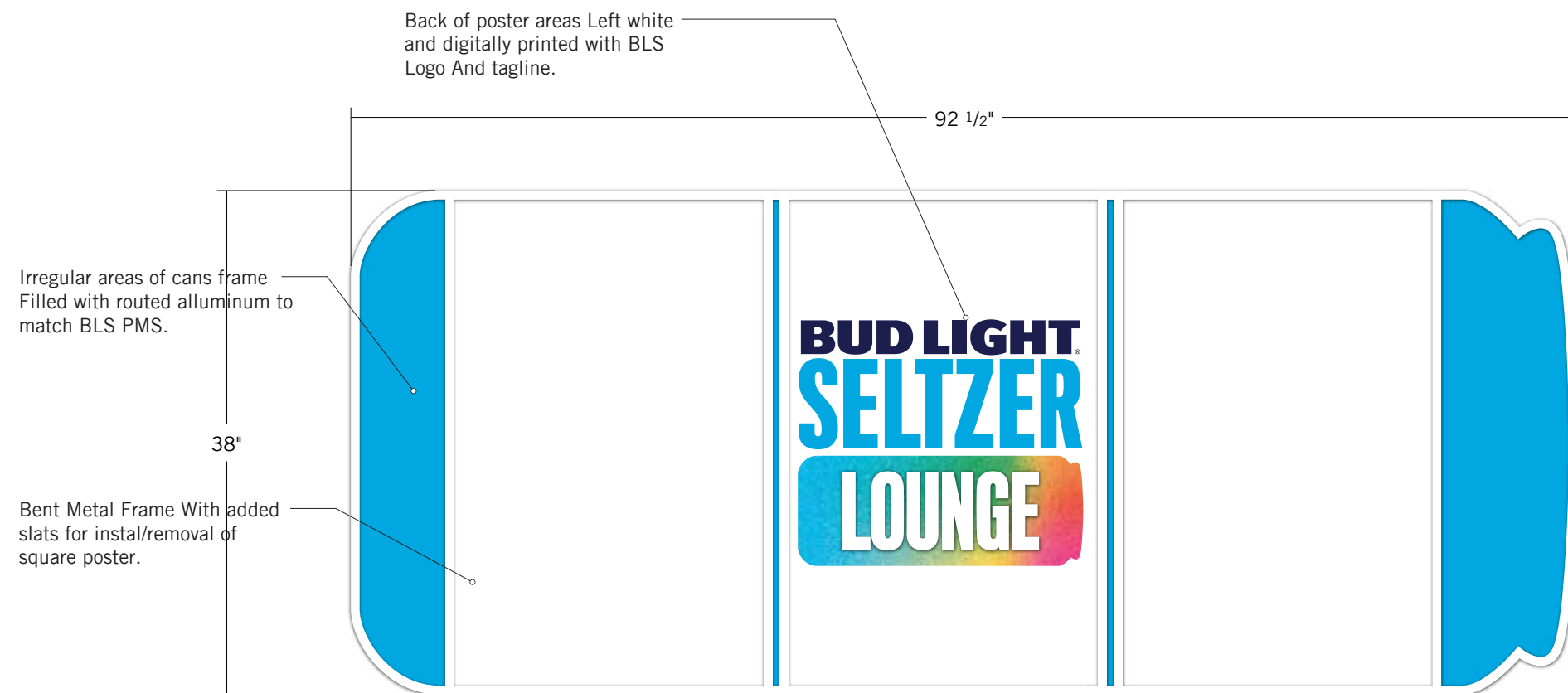

DETAIL - BLS CAN POSTER FRAME

Scale: 1" = 1'- 0"

Pantone 2985 C
BM 2060-50 Cayman Blue

Pantone 2766
BM 2065-10 Admiral Blue

White

ELEVATION - BACK SIDE & INSTAGRAMABLE MOMENT

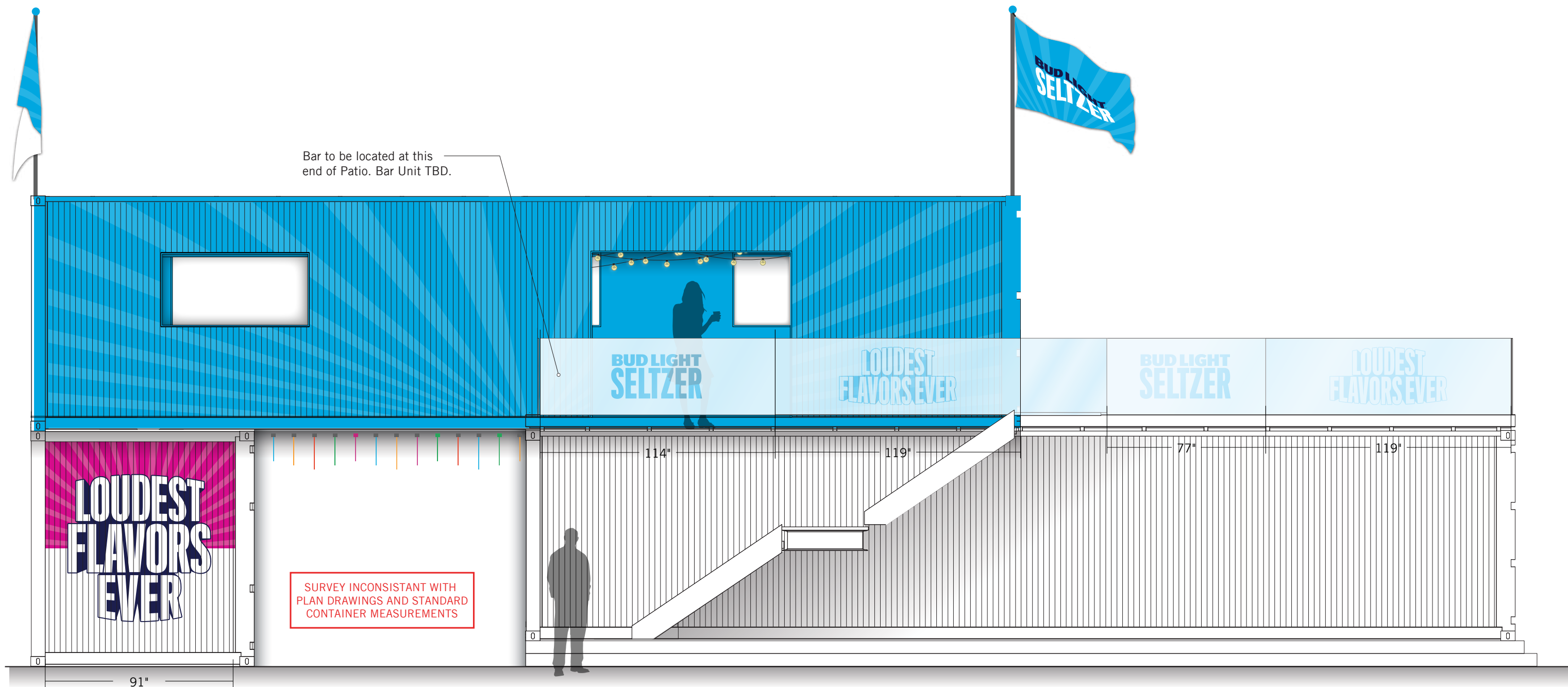

ELEVATION

Scale: 1/4" = 1'-0"

EX.08.1 BLS CONTRAINER WRAP - BACK SIDE

DESIGN APPROVED
FOR PRODUCTION



CONFIRM MEASUREMENTS
SPECIAL MOUNT VINYL WRAP
OVER CORRUGATION

Digitally printed ACM Panel
stacked and mounted to
container TBD. Panels edges are
at color break



CURRENT CONDITIONS

Scale: NTS

EX.08.1 - ELEVATION

Scale: 3/4" = 1'- 0"

Pantone 233 C
BM 2077-30 Hot Lips

Pantone 2766
BM 2065-10 Admiral Blue

Pantone 2046
BM 2078-40 Hot Lips

White

PLAN VIEW _ PATIO SEATING ORIENTATION

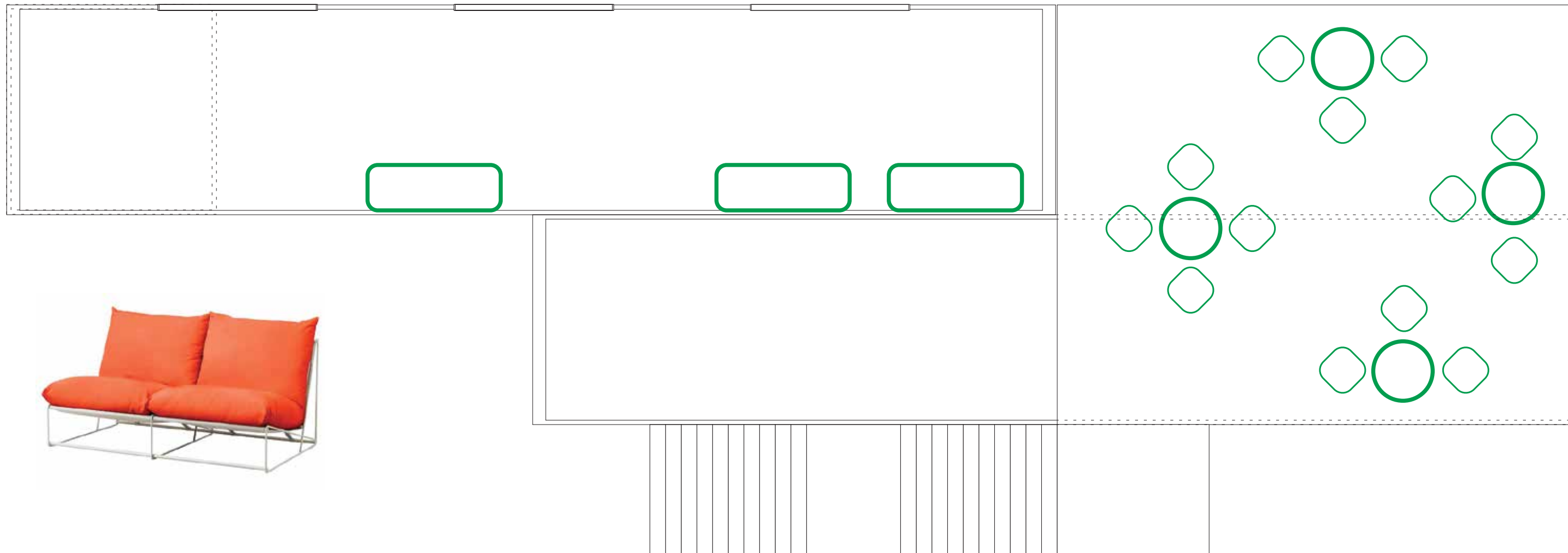

ELEVATION - RIGHT SIDE & BANNISTER DETAIL



Logo lettering to be 1/4" acrylic painted white and blue to match BLS Light Blue

TOP

FRONT

Base to match BL Dark Blue



Pantone 2995 C
BM 2060-40 Toronto Blue

Pantone 2985 C
BM 2060-50 Cayman Blue

Pantone 2766
BM 2065-10 Admiral Blue

White

ELEVATION - BL BRANDED TALLBOY BAR TABLE

Scale: 1" = 1'- 0"

EX.13 BLS LFE FLAGS - DETAIL

DESIGN APPROVED
FOR PRODUCTION

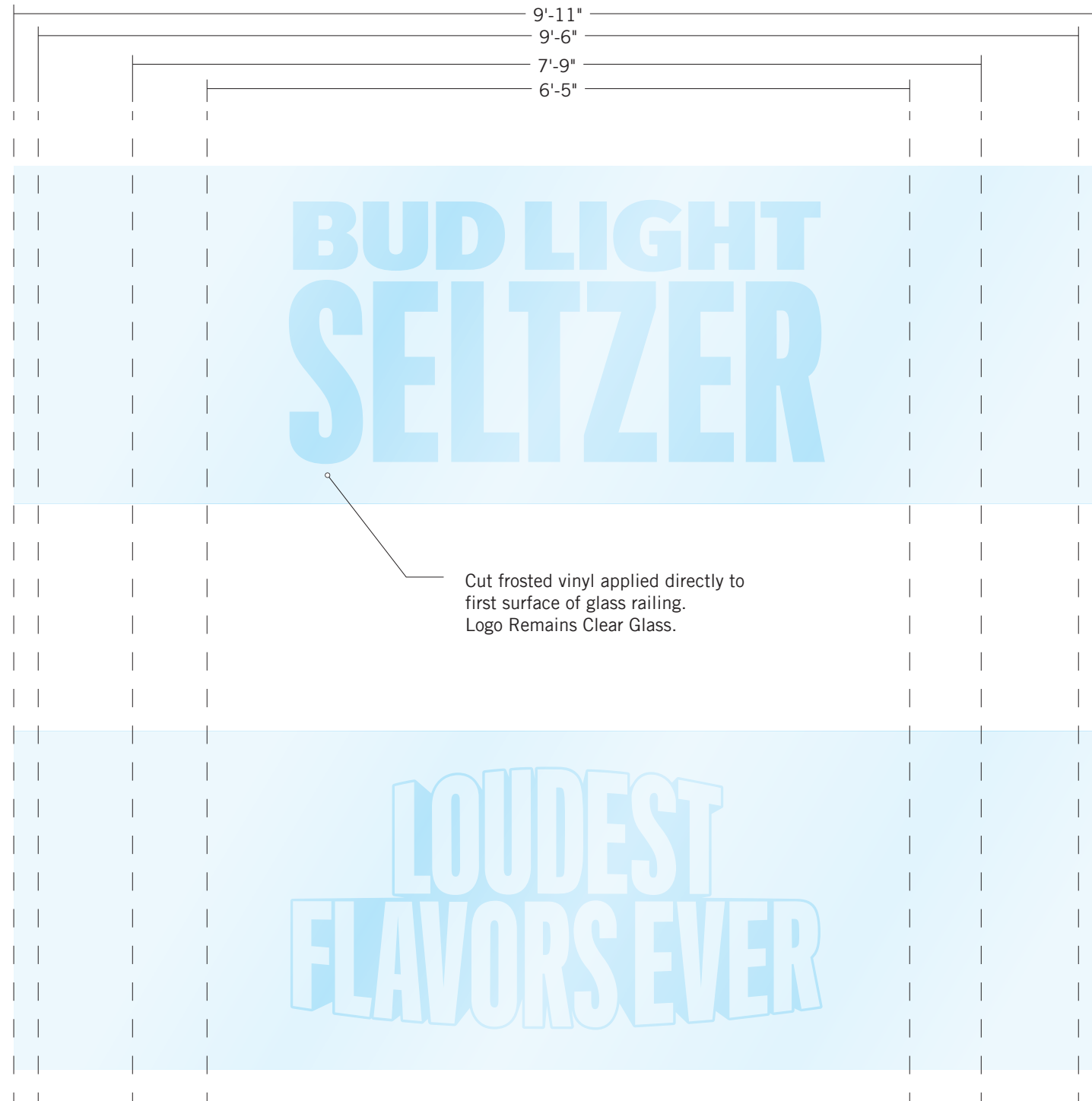

BUDLIGHT SELTZER WRAP - QTY 4
 9'-11" - QTY 1
 9'-6" - QTY 1
 7'-9" - QTY 1
 6'-5" - QTY 1

LOUDEST FLAVORS EVER WRAP - QTY 5
 9'-11" - QTY 3
 9'-6" - QTY 0
 7'-9" - QTY 2
 6'-5" - QTY 0

EX-13 FROSTED VINYL BANNISTER DESIGN

Scale: 3/4" = 1'- 0"

RENDER DRAWINGS



RENDER DRAWING - REAR RIGHT 3/4 VIEW

Scale: 1/4" = 1'- 0"

ELEVATION - LEFT SIDE

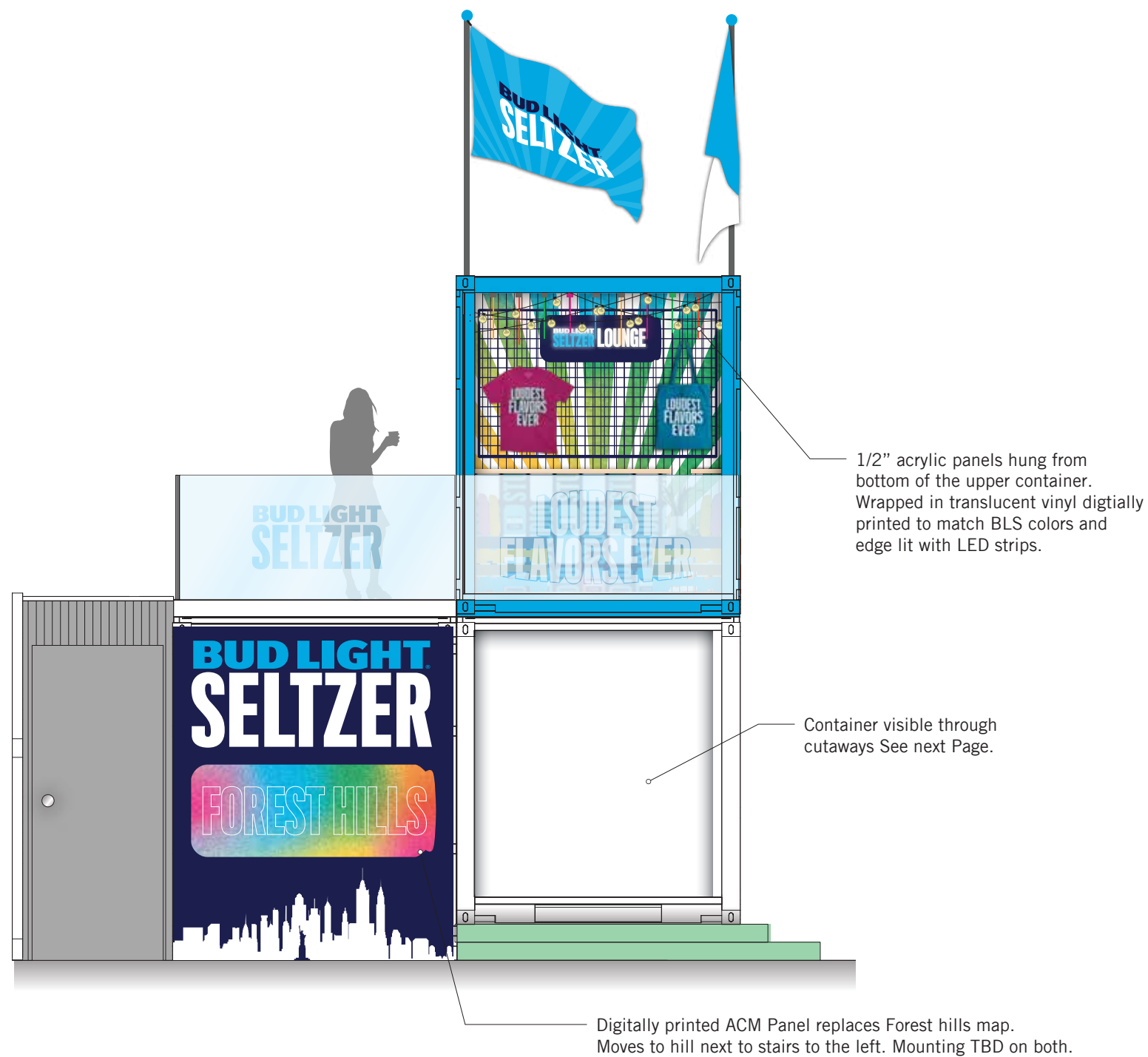

ELEVATION

Scale: 1/4" = 1'- 0"



CURRENT CONDITIONS

Scale: NTS

Pantone 7482 C BM 2033-20 Peppermint Leaf	Pantone 137 C BM 2018-10 Orange Sky
Pantone 2257 C BM 2032-30 Fresh Lime	Pantone 143 C BM 2018-40 Nacho Cheese
Pantone 3556 C BM 2012-13 Tawny Day Lily	Pantone 2995 C BM 2060-40 Toronto Blue
Pantone 2348 C BM 2012-30 Tangerine Dream	Pantone 2985 C BM 2060-50 Cayman Blue
Pantone 233 C BM 2077-30 Hot Lips	Pantone 2766 BM 2065-10 Admiral Blue
Pantone 2046 BM 2078-40 Hot Lips	White

EX.09 BLS ENTRY "FOREST HILL" WALL

DESIGN APPROVED
FOR PRODUCTION



CURRENT CONDITIONS

Scale: NTS

Digitally printed ACM Panel
replaces Forest hills map.
Map Moves to hill next to stairs
to the left. Mounting TBD on both.

CONFIRM MEASUREMENTS
SPECIAL MOUNT TBD

EX. 09 - ELEVATION

Scale: 3/4" = 1'- 0"

- Pantone 2995 C
BM 2060-40 Toronto Blue
- Pantone 2985 C
BM 2060-50 Cayman Blue
- Pantone 2766
BM 2065-10 Admiral Blue
- White

IN.01 BLS PMS ACRYLIC BLADE LIGHT FEATURE

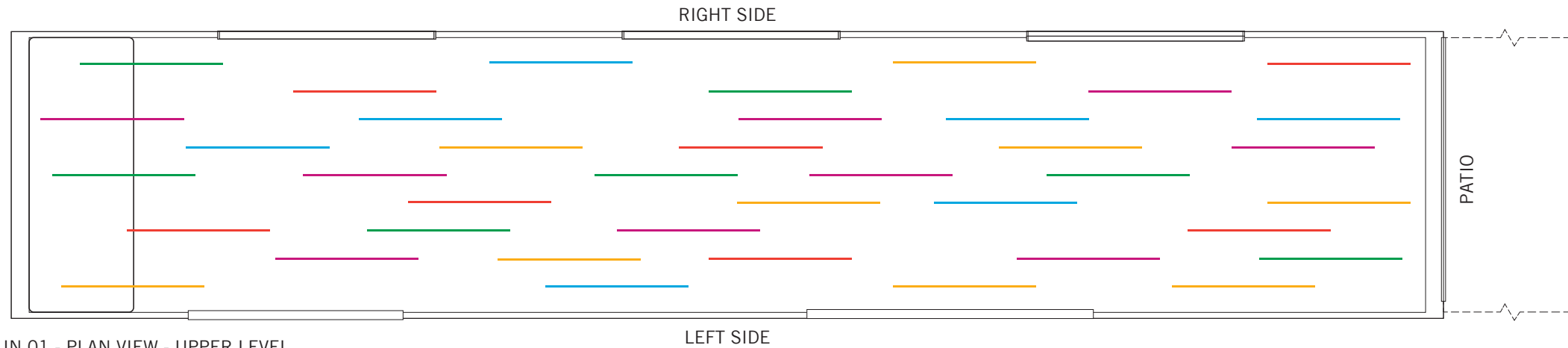

IN.01 - PLAN VIEW - UPPER LEVEL

Scale: 1/4" = 1'- 0"

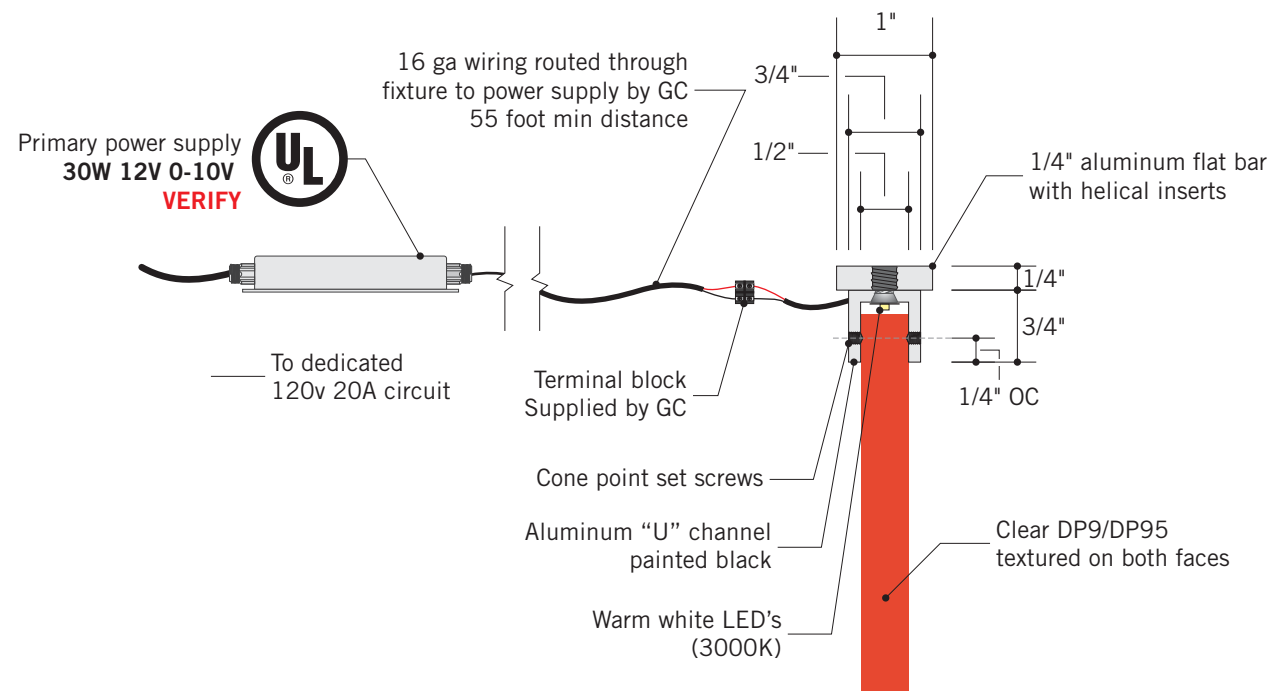

IN.01 - ACRYLIC LIGHTING FEATURES - SIDE VIEW - PREFERRED OPTION

Scale: 1:2

1/2" clear acrylic blades edge lit from top with LED's. Wrapped in various colors of translucent colored vinyl to match BLS PMS.



IN.01 - ACRYLIC LIGHTING FEATURES - SIDE VIEW - PREFERRED OPTION

Scale: 1/2" = 1'- 0"

48" Colored LED tube lights to match BLS PMS. Affixed to ceiling tbd.

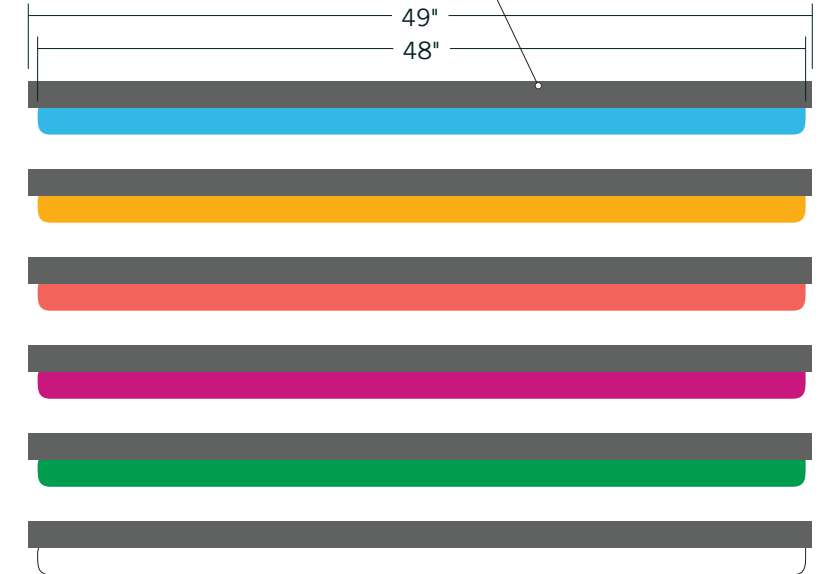

IN.01 - ACRYLIC LIGHTING FEATURES - SIDE VIEW - FALLBACK OPTION

Scale: 1/2" = 1'- 0"



IN.01 - ACRYLIC LIGHTING FEATURES - FRONT VIEW - FALLBACK OPTION

Scale: 1/2" = 1'- 0"

Pantone 7482 C BM 2033-20 Peppermint Leaf	Pantone 137 C BM 2018-10 Orange Sky
Pantone 2257 C BM 2032-30 Fresh Lime	Pantone 143 C BM 2018-40 Nacho Cheese
Pantone 3556 C BM 2012-13 Tawny Day Lily	Pantone 2995 C BM 2060-40 Toronto Blue
Pantone 2348 C BM 2012-30 Tangerine Dream	Pantone 2985 C BM 2060-50 Cayman Blue
Pantone 233 C BM 2077-30 Hot Lips	Pantone 2766 BM 2065-10 Admiral Blue
Pantone 2046 BM 2078-40 Hot Lips	White

IN.04 SCREEN PRINTING STATION BACKER & IN.04.1 SCREEN PRINTING CABINETY

SURVEY REQUIRED PRIOR TO
PRODUCTION & INSTALL

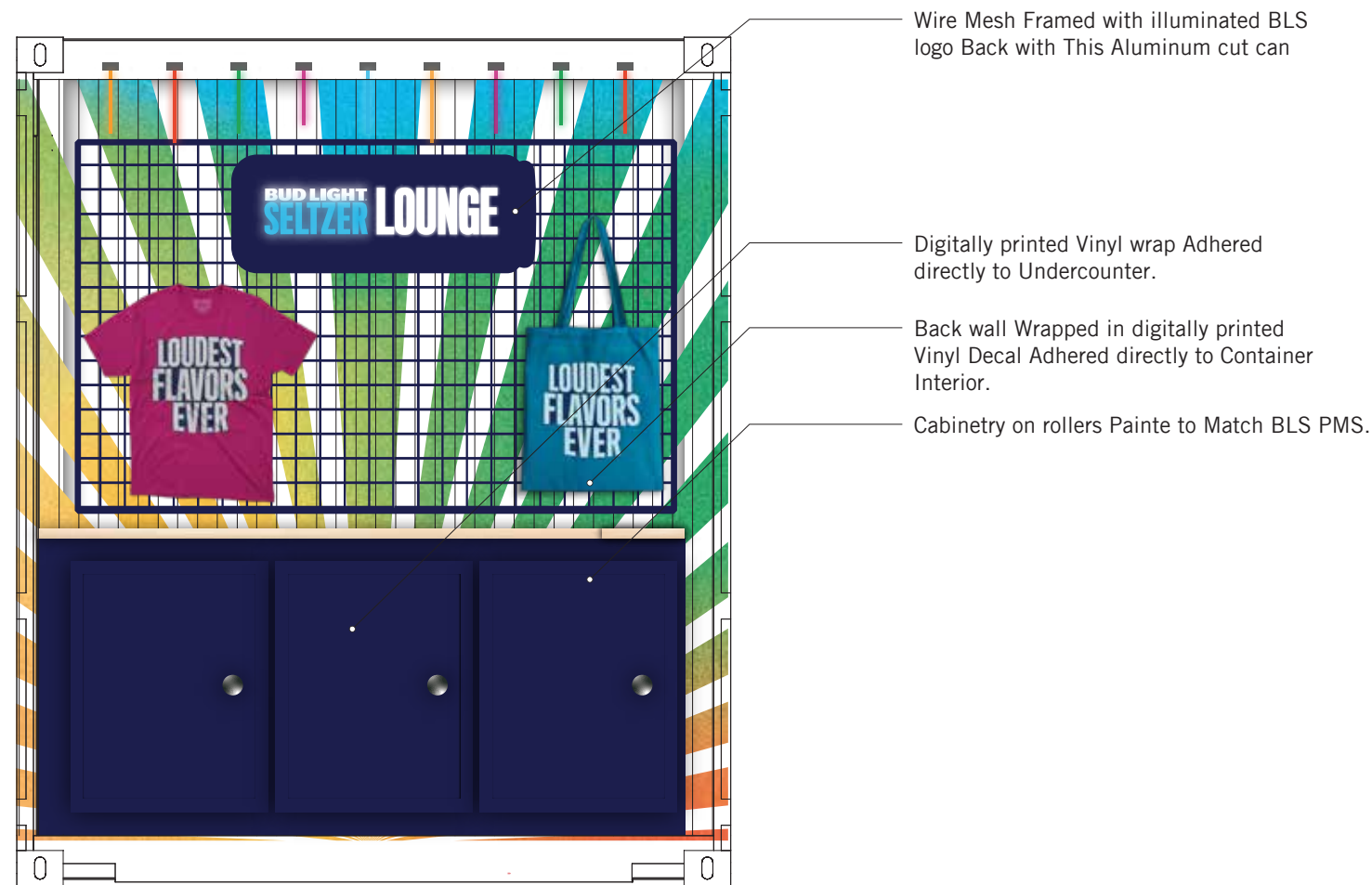

SCREEN PRINTED T-SHIRT AND TOTE
Scale: NTS

IN04 - ELEVATION - UPPER BAR FROM PATIO

Scale: 1/2" = 1'- 0"

Pantone 2995 C BM 2060-40 Toronto Blue
Pantone 2985 C BM 2060-50 Cayman Blue
Pantone 2766 BM 2065-10 Admiral Blue
White

IN.03 "BE LOUD QUEENS" WALL GRAPHICS & IN.11 DIGITALLY PRINTED CUT CANS

Digitally printed 1/2" acrylic cut can Menu Mounted directly to Containers Surface.

Cut Vinyl or paint mask Queens Messaging.



IN 03 & IN.11 - ELEVATION - UPPER LEVEL - LEFT SIDE

Scale: 1/4" = 1'- 0"

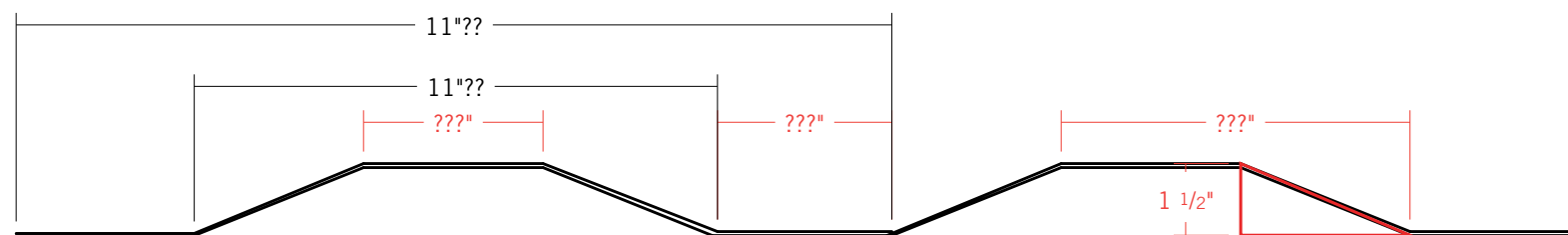

CONFIRM INTERNAL
CORRUGATIONIS MEASUREMENTS &
OF RIDGES BETWEEN DOOR AND WINDOW

EX.01.1 - CORRUGATION CLARIFICATION

Scale: 3" = 1'- 0"

IN.02 DIMENSIONAL LFE BAR SIGN

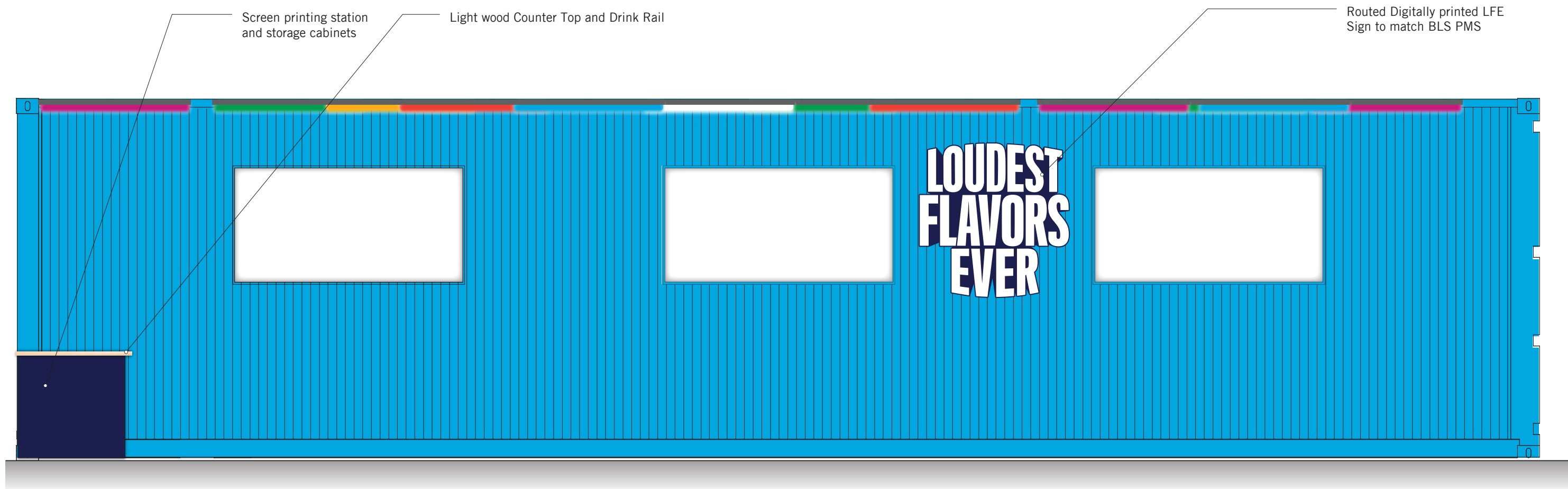

IN.02 - ELEVATION - RIGHT SIDE

Scale: 1/4" = 1'- 0"

EX.13 BLS LFE FLAGS - DETAIL

DESIGN APPROVED
FOR PRODUCTION



EX.13 - FLAG DESIGN - BLS

Scale: 1" = 1'- 0"



EX.13 - FLAG DESIGN - LFE

Scale: 3/4" = 1'- 0"

Pantone 2995 C
BM 2060-40 Toronto Blue

Pantone 2985 C
BM 2060-50 Cayman Blue

Pantone 2766
BM 2065-10 Admiral Blue

White

messenger **SPORTS**



Anheuser-Busch